

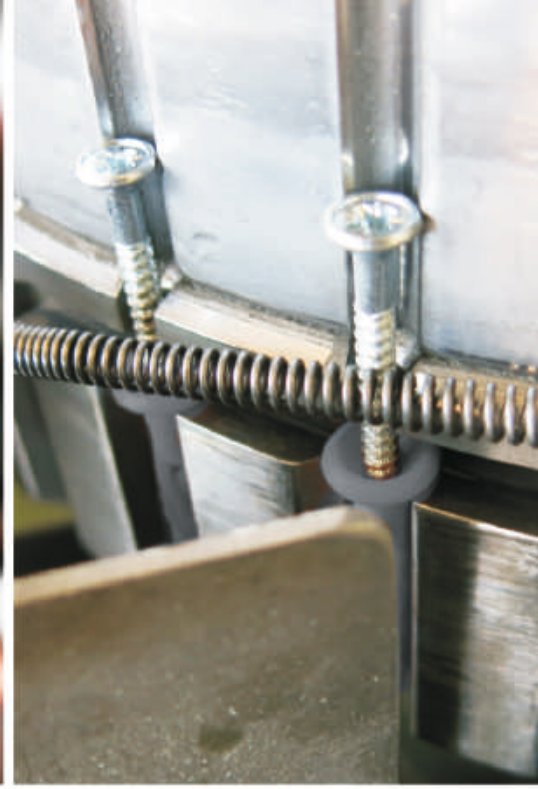

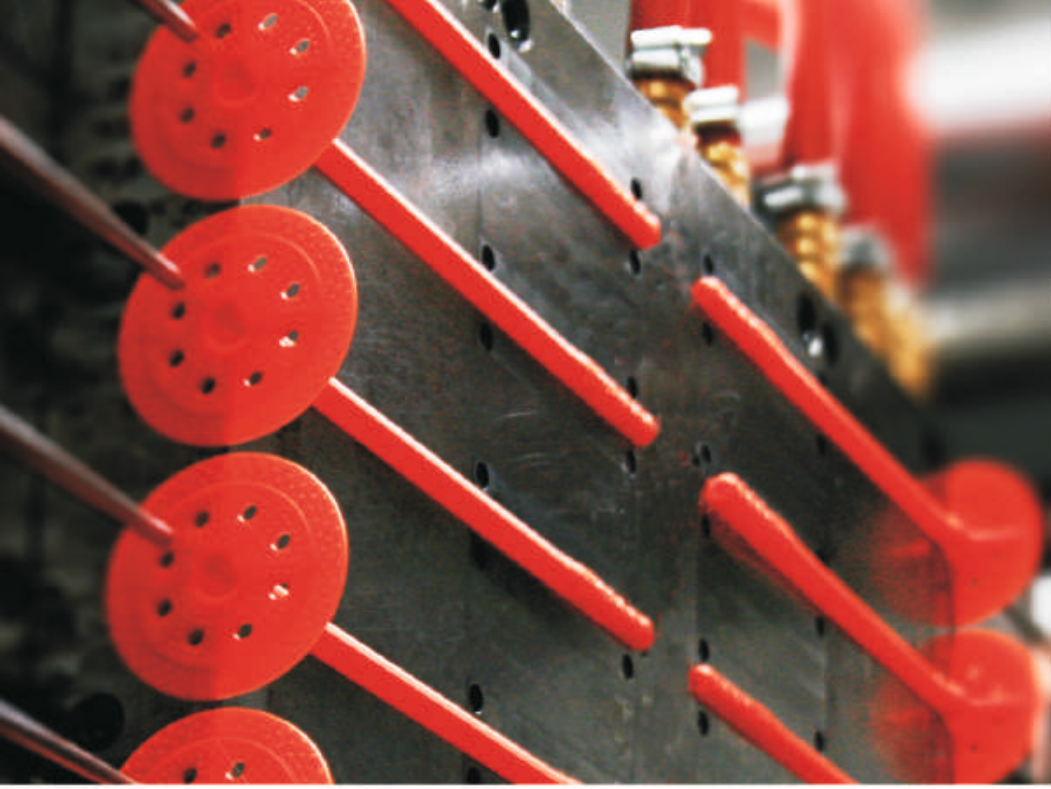





















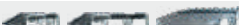









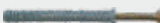

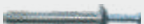

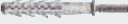
# **TECHNIKA ZAMOCOWAŃ**

FASTENERS & FIXING SYSTEMS

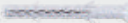
# **2021**





1 MOCOWANIA TRADYCYJNE UNIWERSALNE TRADITIONAL FIXINGS		6-9
Koszulka kołka rozporowego	Plug for solid materials	K...  6
Kołek rozporowy z wkrętem	Plug with a cross-headed wood screw	...+...  6
Kołek rozporowy z hakiem kątowym	Plug with hook	..K  6
Kołek rozporowy z hakiem sufitowym	Plug with ceiling hook	..S  6
Kołek rozporowy z hakiem huśtawkowym	Plug with swing hook	12H  6
Kołek rozporowy z wkrętem z łbem sześciokątnym	Plug with a pan cap wood screw	.../...  7
Komplet do mocowania umywalk	Set for fixing washbasins	KPU  7
Komplet do mocowania muszli klozetowych	Set for fixing toilet bowls	KPM  7
Koszulka kołka uniwersalnego	Universal plug	KS  8
Kołek uniwersalny z wkrętem	Universal plug with screw	KS  8
Kołek uniwersalny z hakiem kątowym	Universal plug with hook	KS..K  8
Kołek uniwersalny z hakiem sufitowym	Universal plug with ceiling hook	KS..S  8
Kotwa wbijana metalowa do płyt GK	Hammer-in fixing for plasterboard	KG  8
Kołek rozporowy do gazobetonu	Universal plug for aerated concrete	KRG, KGB  9
2 MOCOWANIA DO ŚCIAN GIPSOWO - KARTONOWYCH FIXINGS FOR PLASTERBOARD WALLS		9-11
Kołek stalowy typ "MOLLY"	Hollow wall anchor	SM  9
Ściągacz do śrub "MOLLY"	Screw puller molly	AT-88  9
Kołek do zamocowań w płytach G-K	Driva pin for plaster walls	DRIVA  10
Końcówka do wkrętarki typ "DRIVA"	Screwdriver bit for spit driva	DRIVA-KW  10
Kołek rozporowy do pustych przestrzeni	Toggle anchor for empty spaces	G, GL, GK  10
Kotwa sprężynowa do pustych przestrzeni z wkrętem	Toggle anchor	SP  10
Wkręt samowierzący (fosfatowany / ocynkowany)	Self drilling screws	WS  11
Wkręt fosfatowany do blachy / drewna	Drywall screws	FS, FT, FTP  11
3 KOŁKI SZYBKIEGO MONTAŻU HAMMER DRIVE PLUGS		12
Kołek do wbijania z lejkami	Hammer drive plug with nail	..L...  12
Kołek do wbijania z kołnierzem	Hammer drive plug with nail t-type	..K...  12
Metalowy kołek do wbijania	Zinc alloy nail in anchor	KMW  12
Kotwa rozprężna do montażu sufitów podwieszanych	Hammer drive in anchor for suspended	GS  12
4 MOCOWANIA RAMOWE PLUGS FOR SOLID MATERIALS		13-23
Kołek z długą płaszczyzną podziału z wkrętem	Frame fixing with countersunk head screw	PX  13
Kołek z długą płaszczyzną podziału z wkrętem do drewna	Frame fixing with hexagonal head screw	PK  13
Kołek z długą płaszczyzną podziału z hakiem sufitowym	Frame fixing with ceiling hook	PKS  14
Kołek z długą płaszczyzną podziału z hakiem prostym	Frame fixing with hook	PKH  14
Koszulka kołka z długą płaszczyzną podziału	Frame plug	KRK  15
Kołek z długą płaszczyzną podziału	Frame fixing with screw	KR, KR D  15
Wkręt hartowany do drewna, płyt wiórowych i PCV	Chipboard screws countersunk flat	UC  16-17
Wkręt tarasowy	Terrace screws	WT  17
Wkręt z łbem talerzowym do drewna i płyt wiórowych	Construction flange head screw	UCSP  18
Wkręt z łbem stożkowym do drewna	Construction flat head screw	UCT  19-20



# Spis treści

## Table of Contents











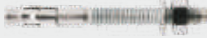









Wkręt hartowany do mocowania ościeżnic	Concrete screws	WHO/WHOW		20
Kotwa stalowa do ościeżnic	Metal frame anchor	O., O..K		21
Wkręt samowiertny do stolarki PCV	Windows buliding self-drilling screws	KS		21
Wkręt do mocowania okuć z łbem stożkowym	Windows buliding self-taping screws	KSO		21
Wkręt do cienkich blach, ze skrzydełkami	Self drilling screws with wings	KSS		21
Zaślepka (konfirmant, PZ, TORX)	Plastic caps	ZW...		22
Kotwa metalowa do stolarki okiennej i drzwiowej	Mounting anchor for windows	KM		22
Wkręt montażowy uniwersalny	Wafer head phillips (sharp point)	WM, WMF		23
Wkręt montażowy samowiertny	Wafer head phillips (self-drilling)	WMS, WMSF		23

### 5

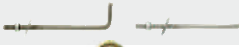
#### MOCOWANIA ŚREDNICH I DUŻYCH OBCIĄŻEŃ

HEAVY DUTY FIXINGS

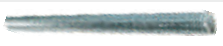
24-32

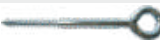





Łącznik pierścieniowy	Wedge anchor	ŁP		24
Kotwa opaskowa z oczkiem sufitowym	Ceiling anchor with eye yellow zinc	SRS		24
Kotwa śrubowa do betonu Anchor Bolt	Anchor Bolt	FCB		25
Kotwa rozprężna	Sleeve anchors (yellow zinc)	KT		25
Kotwa rozprężna z hakiem sufitowym	Sleeve anchors with ceiling hook	KTS		25
Stalowy łącznik jedno i dwurozporowy SŁR	Steel anchor bolt	J, D		25-26
Stalowy łącznik dwurozporowy z hakiem otwartym	Steel anchor bolt with ceiling hook	HO		27
Stalowy łącznik dwurozporowy z hakiem zamkniętym	Steel anchor bolt with hook o-type	HZ		27
Stalowy łącznik dwurozporowy z hakiem prostym	Steel anchor bolt with hook	HP		27
Stalowy łącznik jednorozporowy z hakiem huśtawkowym	Steel anchor bolt with swing hook	HH		27
Tuleja mosiężna	Brass anchors	TM		28
Tuleja stalowa	Drop in anchors	TS		28
Osadzak i wiertło do tulei stalowych	Drop in anchor setting tool	OTS, N-SDS		28
Zacisk TKL	Beam clamp	TKL		28
Łącznik śrubowy TYP L	T-rod L-type	KML, KMLO		29
Hak huśtawkowy	Hook pigtail	HHH		29
Hak oczkowy zamknięty	Hook o-type	HHZ		30
Hak oczkowy otwarty	Hook c-type	HHO		30
Hak prosty	Hook square	HHP		30
Pręt gwintowany	Threaded rod	PRI, PRIA		31-32
Nakrętka złączna	Coupling nuts	NZ		32
Hak do rusztowań	Eye bolt, welded	HRR		32

### 6

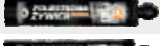
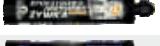
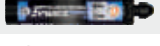

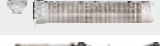

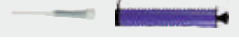

































#### SYSTEM KOTEW CHEMICZNYCH

CHEMICAL ANCHORS

33-34

Żywica chemiczna poliestrowa	Chemical Anchors Polyester	KCH		33
Żywica chemiczna epoksydowo-akrylowa	Chemical Anchors Epoxy-acrylate	KCH		33
Żywica winyloestrowa	Chemical Anchors Vinyl-ester	KCH		33
Pręt gwintowany z zakończeniem heksagonalnym	Chemical Anchor Threaded Rod	KCH		33
Tuleja siatkowa	Plastic sleeve	KCH		33
Wyciskacz do mas	Caulking gun for chemical anchors	N-W		34
Akcesoria (mikser, pompka do wydmuchiwania zwiercin)	Accessories (mixing nozzle, blow out pump)	KCH		34
Szczotka do czyszczenia otworów	Hole cleaning brush	KCH		34

















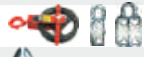









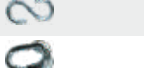







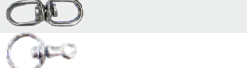







<b>7</b>	<b>MOCOWANIA IZOLACJI TERMICZNYCH - FASADY I DACHY</b> THERMAL INSULATION FIXING		<b>35-38</b>
	Łącznik do izolacji z krótką strefą rozporową	Connector for insulation	ŁIN, ŁIMO  <b>35</b>
	Łącznik do izolacji z przedłużoną strefą rozporową	Connector for insulation	ŁIPN, ŁIPMO  <b>35</b>
	Frez tworzywowy	Cutter for holes	STYR-01,06  <b>36</b>
	Zaślepka styropianowa/wetniana	Styrofoam/mineral wool plug	STYR-02,03,05  <b>36</b>
	Kołnierz bez wkręta	Pressure flange with a plug	ŁIK  <b>36</b>
	Talerzyk dociskowy do mocowania wełny	Pressure plate for fastening wool	KWL  <b>36</b>
	Dybel do mocowania w fasadzie	Pin for fastening	PFI  <b>36</b>
	Podkładka dystansowa pod zbrojenie	Reinforcement spacers	DYS  <b>36</b>
	Tuleja do mocowania pokryć dachowych	Telescopic sleeve with round plate	GOK  <b>37</b>
	Łącznik izolacyjny do betonu	Insulation screws for concrete construction	GTHD  <b>38</b>
	Wkręt do blach	Self-drilling screw for steel assembly	EDSS, EDSB  <b>38</b>
	Łącznik do dachów betonowych	Plug for concrete roofs	KKW  <b>38</b>
<b>8</b>	<b>GWOŹDZIE</b> STEEL NAILS		<b>39-41</b>
	Gwoździe utwardzane	Hardened steel nails	GU  <b>39</b>
	Gwoździe utwardzane walcowane	Hardened steel nail grooved shank	GUW  <b>39</b>
	Gwoździe utwardzane walcowane z podkładką	Hardened steel nail grooved shank with washer	GUP  <b>39</b>
	Gwoździe stolarskie ocynkowane i miedziane	Finishing nail	GSO, GSM  <b>39</b>
	Gwoździe budowlane czarne	Common nails	GWBU  <b>40</b>
	Gwoździe „ANCHOR”	Steel nails "Anchor"	GKA  <b>40</b>
	Gwoździe papowe z podkładką	Roofing nails	GWPAP  <b>40</b>
	Gwoździe papowe	Roofing nails	GWPA  <b>40</b>
	Gwoździe skręcane	Square twisted nails	GWS  <b>41</b>
	Gwoździe SKOBLE do montażu siatki	U-nails	SKO  <b>41</b>
<b>9</b>	<b>WKRETY SAMOWIERTNE</b> SELF DRILLING SCREWS		<b>41-43</b>
	Blachowkręt samowiertny z gniazdem kwadratowym	Pan head screw with square recess	WMW  <b>41</b>
	Blachowkręt samowiertny z łbem walcowym	Pan head sheet metal screw	OCS  <b>41</b>
	Podkładka EPDM	EPDM washer	EPDM  <b>42</b>
	Wkręt samowiertny do mocowania blach	Self drilling screw, hex washer head	OC  <b>42</b>
	Wkręt samowiertny z podkładką EPDM	Self drilling screw with EPDM washer	OCG  <b>43</b>
<b>10</b>	<b>MOCOWANIA DACHOWE</b> ROOF FIXING		<b>43-45</b>
	Wkręt samowiertny do płyt warstwowych	Self-drilling roofing screw with EPDM washer	OWG, OWB  <b>43-44</b>
	Wkręt farmerski GUNNEBO typu PAN HEAD	Panhead farmer screw	FTX  <b>44</b>
	Wkręt farmerski	Self-drilling farmer screw with EPDM washer	OD, ODI  <b>44-45</b>
	Farba zaprawkowa	Spray primers	FA  <b>45</b>
	Kołnierz uszczelniający	Sealing collar	MF  <b>45</b>
<b>11</b>	<b>NITY I NARZĘDZIA DO NITOWANIA</b> RIVETS AND RIVETING TOOLS		<b>46-47</b>
	Nit zrywalny Al/Fe	Open type blind rivet with dome head, Al/Fe	NIT  <b>46</b>
	Nit zrywalny ze stali nierdzewnej A2 (INOX/INOX)	Open type blind rivet with dome head, A2	NITN  <b>46</b>
	Nit zrywalny Al/Fe lakierowany	Open type blind rivet with dome head, Al/Fe	NITL  <b>46</b>
	Nit zrywalny Fe/Fe	Open type blind rivet with dome head, Fe/Fe	NITS  <b>47</b>
	Nit zrywalny Cu/Fe	Open type blind rivet with dome head, Cu/Fe	NITMS  <b>47</b>
	Nitonakrętka stalowa	Rivets nuts	NITONA  <b>47</b>
	Nitownica K2 tools	Hand riveter	N-NIT  <b>47</b>



# Spis treści

## Table of Contents

12 LINY I AKCESORIA DO LIN		ROPE AND ACCESSORIES FOR ROPES		48-59
Lina stalowa	Steel wire ropes, galvanized	LSZ		48
Lina stalowa w powłoce PCV	Steel wire ropes, galvanized, PVC coated	LPS		49
Lina stalowa z pętelkami	Steel wire rope with loops	LSZP		49
Lina pleciona	Braided (polypropylene) twine	LP		49
Lina elastyczna	Braided flexible twine	LPG		49
Sznurek murarski	Mason twine	SZM		49
Lina jutowa	Jute twine	LJ		49
Bloczek budowlany	Pulley	BLOB, BLO		50
Kausza	Wire rope thimble	KA		50
Zacisk siodełkowy pojedynczy i podwójny	Single/ double clamp	ZACS, ZACSP		51
Zacisk linowy - kubełkowy	Egg shaped wire rope clip	ZACK		51
Zacisk do lin	Wire rope clip	ZAC		51
Szklą	European type Dee shackle	SZE, SZED, SZEO		52
Śruba rzymska korpus	Turnbuckle	ŚRZK		52
Śruba rzymska	Turnbuckle	ŚRZ, ŚRZH, ŚRZU, ŚRZP		53
Śruba rzymska DIN1480	Turnbuckle	ŚRZD, ŚRZDHH, ŚRZDUU		54
Hak huśtawkowy z karabińczykiem lub szklą	Swing hooks	HHK, HHS		55
Hak zwykły z zabezpieczeniem	Hook	HAK, ...U, ...Z, ...S, ...O		55-56
Ogniwo typ „S”	Quick link type S	OGN		56
Ogniwo zaklepywane	Repair link	OGZ		56
Ogniwo skręcane	Quick link	OGS		56
Kółko zgrzewane	Steel welded ring	KZ		56
Śruba z uchem	Eye screw	ŚRU		57
Nakrętka z uchem	Eye nut	NAKU		57
Karabińczyk ozdobny	Snap hook	KAR		57
Karabińczyk do lin	Snap hook	KAR, KARZ		57
Naciąg do siatki, śruba naciągowa	Wire stretcher	NAC		58
Zawlecza rolnicza	Spring pin	ZAW, ZAB		58
Zawlecza rozginana	Linch pin	ZAR		58
Spinacz do łańcuchów	Swivel snap hook	SP, SPO		59
Krętlik dwustronny niklowany	Swivel nickel plated	KREN		59
Okrętka super	Swivel link	OKR		59
Tuleja aluminiowa typ A	Aluminum sleeve	TA		59
13 ŁAŃCUCHY		STEEL CHAIN		60-61
Łańcuch techniczny	Technical steel chain	ŁA		60
Łańcuch gospodarczy „D-1”	Steel chain type D1	ŁAG		60
Łańcuch gospodarczy „D-2”	Steel chain type D2	ŁAGD		60
Łańcuch gospodarczy „D-1”, ocynk ogniowy	Hot Dip Galvanized Chain	ŁAGO		60
Łańcuch plastikowy	Plastick Chain	ŁAPL		60
Łańcuch węzłowy „Viktor”	VICTOR nodal chain	ŁAV		61
Łańcuszek niezgrzewany ocynkowany	Zinc-plated steel chain	ŁAN		61
Łańcuch spinający	Spanning chain	ŁASP		61
Łańcuch dla psa	Steel chain for dog	ŁAP		61
Łańcuch gospodarczy (pastwiskowy, żłobowy)	Grazing steel chain / Black manger chain	ŁAPA, ŁAŻ		61



<b>14</b>	<b>ELEKTRODY SPAWALNICZE</b> WELDING ELECTRODES			<b>62-63</b>
	Elektroda RC, zasadowa PLASMA, INOX	Welding electrode	EL	62
	Drut spawalniczy	Welding wire	DRS, DR	62-63
	Elektroda ER 146 i 150	Welding electrode	ELER, ELEB	63
	Elektroda OVERCORD E	Welding electrode	ELO	63
	Elektroda i RUTILEN-12	Welding electrode	ELR, ELRP	63
	Elektroda INOX 308L	Welding electrode	EL...-INOX	63
<b>15</b>	<b>UCHWYTY I OBEJMY</b> BANDS AND CLAMPING RINGS			<b>64-66</b>
	Hak grzejnikowy - kątowy	Galvanized bent radiator hook	HGK, HGKM	64
	Hak grzejnikowy - prosty	Galvanized radiator hook with long	HG, HGM	64
	Uchwyt metalowy do rur	Pipe clamp	U, UP	64
	Uchwyt metalowy do rur z uszczelką	Pipe clamp with gasket	UT, UPT	64
	Uchwyt boczny do rur	Pipe clamp with gasket	UB, UBT	64
	Taśma SERRATUB W2 9mm	Hose Clamp Roll	TAŚ, ZAMEK	64
	Opaska ślimakowa K-2	GM (GERMAN MIDDLE) type hose clamp	OBI, OBN	65
	Opaska GBS	GBS pipe clamp	OBB	65
	Cybant, łącznik do cybantów	U-bolt, connector	CYBB, CYBŁ, CYBK	66
<b>16</b>	<b>ZŁĄCZA CIESIELSKIE SIMPSON Strong-Tie</b> CONNECTORS FOR TIMBER			<b>67-71</b>
<b>17</b>	<b>METALOWE SYSTEMY NOŚNE</b> METAL SUPPORTING SYSTEMS			<b>72-74</b>
<b>18</b>	<b>ŚRUBY, PODKŁADKI, NAKRĘTKI</b> SCREWS, WASHERS, NUTS			<b>75-82</b>
	Podkładka okrągła zgrubna	Round washer	POD	75
	Podkładka okrągła poszerzona	Enlarged round washer	POP30	75
	Podkładka okrągła poszerzona	Enlarged round washer	POP19	75
	Podkładka sprężysta	Spring washer	PODS	76
	Podkładka do konstrukcji drewnianych	Wood construction washers	POK	76
	Nakrętka pazurkowa	T-nut	NAKP	76
	Nakrętka sześciokątna	Metric hexagon nut	NAK, NAKC	76
	Nakrętka samokontrująca z wkładką poliamidową	Plain nylon insert lock nut	NAKWK	77
	Nakrętka kołpakowa	Hexagonal domed cap nut	NAKK	77
	Nakrętka kołnierzowa	Hexagonal flange nut	NAKZ	77
	Nakrętka motylkowa	Wing nut	NAM	77
	Wkręt dwugwintowy	Hanger bolt	WDT	77
	Wkręt do drewna z łbem sześciokątnym	Coach screw	WKR	78
	Śruba z łbem sześciokątnym z gwintem	Hexagonal head bolt fully threaded	ŚS	79
	Śruba z łbem grzybkowym podsadzonym	Round head square neck bolt partially threaded	ŚZA	80-81
	Śruba lemieszowa / płuzna	Plow Bolt	ŚL	81
	Konfirmat	Furniture screws	KONF	82
	Wiertło do konfirmatów	Confirmat drill	WRKON	82
	Klucz do konfirmatów	Key to furniture screw	KONFKL	82
	Mocowanie do schodów na podłożu z betonu	Plug for fixing stair treads	TBB1	82
	Kołpak ochronny na śruby i nakrętki	Bolt protection caps	KOŁSN	82
	Podkładka (nylonowa)	Nylon washer	PDKN	82
	Podkładka szeroka (nylonowa)	Enlarged nylon washer	PDK2N	82
<b>19</b>	<b>BLISTRY - opakowania detaliczne</b> BLISTER PACKAGE			<b>83-93</b>
<b>20</b>	<b>ARTYKUŁY FIRMY FISCHER</b> FISHER PRODUCTS			<b>94-97</b>
<b>21</b>	<b>SYSTEM POZIOMOWANIA PŁYTEK</b> TILE LEVELING SYSTEM			<b>98</b>

## Koszulka kołka rozporowego

Plug for solid materials



INDEX	ROZMIAR SIZE [mm]	ILOŚĆ [szt.] QUANTITY [pcs]		CENA / PRICE 1000 szt./pcs [PLN]
K-05	5 x 25	500	6000	18,00
K-06	6 x 30	500	6000	22,10
K-08	8 x 40	250	3000	36,00
K-10	10 x 50	200	2400	55,20
K-12	12 x 60	100	1200	90,00
K-12/80	12 x 80	50	600	122,50
K-14	14 x 70	50	600	163,00
K-16	16 x 80	50	600	295,00
K-20	20 x 95	25	300	620,00

## Kołek rozporowy z wkrętem z łbem stożkowym z nacięciem krzyżowym typ POZIDRIVE

Plug with a cross-headed wood screw type POZIDRIVE



INDEX	ROZMIAR SIZE [mm]		ILOŚĆ [szt.] QUANTITY [pcs]		CENA / PRICE 1000 szt./pcs [PLN]
05+	5 x 25	3,5 x 30	200	4800	34,00
06+	6 x 30	3,5 x 30	200	4800	37,20
06+340	6 x 30	3,5 x 40	200	4800	45,00
06+350	6 x 30	3,5 x 50	200	4800	47,30
06+440	6 x 30	4,0 x 40	200	4800	48,00
06+450	6 x 30	4,0 x 50	200	4800	54,45
08+	8 x 40	4,0 x 45	200	2400	61,00
08+450	8 x 40	4,0 x 50	200	2400	68,70
08+460	8 x 40	4,0 x 60	200	2400	72,30
08+550	8 x 40	5,0 x 50	200	2400	99,30
08+560	8 x 40	5,0 x 60	200	2400	109,70
08+580	8 x 40	5,0 x 80	200	2400	124,00
08+100	8 x 40	5,0 x 100	200	2400	172,80
10+560	10 x 50	5,0 x 60	100	1200	121,10
10+580	10 x 50	5,0 x 80	100	1200	148,80
10+660	10 x 50	6,0 x 60	100	1200	174,00
10+680	10 x 50	6,0 x 80	100	1200	225,00
10+100	10 x 50	6,0 x 100	100	1200	262,00

## Kołek rozporowy z hakiem

Plug with hook



INDEX	ROZMIAR SIZE [mm]		ILOŚĆ [szt.] QUANTITY [pcs]		CENA / PRICE 1000 szt./pcs [PLN]
06K	6 x 30	4,0	200	4800	72,00
08K	8 x 40	5,0	200	2400	105,00
10K	10 x 50	6,0	100	1200	170,00
12K	12 x 60	8,0	50	600	355,00
14K	14 x 80	10,0	25	300	760,00

## Kołek rozporowy z hakiem sufitowym i huśtawkowym

Plug with ceiling hook / swing hook



INDEX	ROZMIAR SIZE [mm]		ILOŚĆ [szt.] QUANTITY [pcs]		CENA / PRICE 1000 szt./pcs [PLN]
06S	6 x 30	4,0	200	4800	93,00
08S	8 x 40	5,0	100	1200	160,00
10S	10 x 50	6,0	50	600	253,00
12S	12 x 60	8,0	50	600	505,00
12H	12 x 60	8,0	25	300	1095,00

## Kołek rozporowy z wkrętem z łbem sześciokątnym

Plug with a pan cap wood screw



INDEX	ROZMIAR SIZE [mm]		ILOŚĆ [szt.] QUANTITY [pcs]		CENA / PRICE 1000 szt./pcs [PLN]
08/550	8 x 40	5 x 50	200	2400	129,00
08/560	8 x 40	5 x 60	100	1200	141,00
08/580	8 x 40	5 x 80	100	1200	165,00
10/660	10 x 50	6 x 60	100	1200	207,00
10/680	10 x 50	6 x 80	100	1200	250,00
10/100	10 x 50	6 x 100	50	600	295,00
10/120	10 x 50	6 x 120	50	600	338,00
12/060	12 x 60	8 x 60	50	600	360,00
12/080	12 x 60	8 x 80	50	600	428,00
12/100	12 x 80	8 x 100	25	300	515,00
12/120	12 x 80	8 x 120	25	300	597,00
12/140	12 x 80	8 x 140	25	300	767,00
12/160	12 x 80	8 x 160	25	300	847,00
12/180	12 x 80	8 x 180	25	300	1 182,00
12/200	12 x 80	8 x 200	25	300	1 545,00
14/080	14 x 80	10 x 80	25	300	706,00
14/100	14 x 80	10 x 100	25	300	782,00
14/120	14 x 80	10 x 120	25	300	877,00
14/140	14 x 80	10 x 140	25	300	1154,00
14/160	14 x 80	10 x 160	25	300	1310,00
14/180	14 x 80	10 x 180	25	300	1654,00
14/200	14 x 80	10 x 200	25	300	2012,00
14/220	14 x 80	10 x 220	25	300	2134,00
16/100	16 x 80	10 x 100	25	300	1284,00
16/120	16 x 80	10 x 120	25	300	1345,00
16/140	16 x 80	10 x 140	25	300	1484,00
16/160	16 x 80	10 x 160	25	300	1731,00
16/180	16 x 80	10 x 180	25	300	1923,00
16/200	16 x 80	10 x 200	25	250	2187,00
16/220	16 x 80	10 x 220	25	250	2565,00
20/120	20 x 95	12 x 120	10	120	2345,00
20/180	20 x 95	12 x 180	10	120	3860,00

## Komplet do mocowania umywalk

Set for fixing washbasins



INDEX	ROZMIAR SIZE [mm]		ILOŚĆ [komplet] QUANTITY [set]		CENA / PRICE 1 kpl./set [PLN]
KPU1-100	12 x 60	8 x 100	1	50	2,69
KPU1-120	12 x 60	8 x 120	1	50	2,80
KPU1-140	14 x 80	10 x 140	1	50	3,68

Jeden komplet zawiera 2 sztuki / One set contains 2 pieces

## Komplet do mocowania muszli klozetowych

Set for fixing toilet bowls



INDEX	ROZMIAR SIZE [mm]		ILOŚĆ [komplet] QUANTITY [set]		CENA / PRICE 1 kpl./set [PLN]
KPM-100	10 x 50	6 x 80	1	30	1,37

Jeden komplet zawiera 2 sztuki / One set contains 2 pieces

# Mocowania tradycyjne

## Traditional fixings

### Koszulka kotka uniwersalnego - nylon

#### Universal plug



INDEX	ROZMIAR SIZE [mm]	ILOŚĆ [szt.] QUANTITY [pcs]		CENA / PRICE 1000 szt./pcs [PLN]
KS-05	5 x 32	500	6000	36,00
KS-06	6 x 40	500	6000	50,00
KS-08	8 x 50	200	2400	105,00
KS-10	10 x 60	100	1200	142,00
KS-12	12 x 70	100	1200	197,00
KS-14	14 x 76	100	1200	273,00

### Kotek uniwersalny z wkrętem z tłem stożkowym i nacięciem krzyżowym typu POZIDRIVE

#### Universal plug with a screw type POZIDRIVE



INDEX	ROZMIAR SIZE [mm]		ILOŚĆ [szt.] QUANTITY [pcs]		CENA / PRICE 1000 szt./pcs [PLN]
KS-05035	5 x 32	3,5 x 35	200	2400	52,00
KS-05045	5 x 32	3,5 x 45	200	2400	59,00
KS-06040	6 x 40	4 x 40	200	2400	75,00
KS-06050	6 x 40	4 x 50	200	2400	85,00
KS-06060	6 x 40	4 x 60	200	2400	93,00
KS-08050	8 x 50	5 x 50	100	1200	131,00
KS-08060	8 x 50	5 x 60	100	1200	144,00
KS-08070	8 x 50	5 x 70	100	1200	174,00
KS-10060	10 x 60	6 x 60	50	600	232,00
KS-10070	10 x 60	6 x 70	50	600	264,00
KS-10080	10 x 60	6 x 80	50	600	315,00
KS-10100	10 x 60	6 x 100	50	600	365,00
KS-12080	12 x 70	8 x 80	50	600	785,00
KS-12100	12 x 70	8 x 100	50	600	909,00
KS-12120	12 x 70	8 x 120	50	600	1121,00

### Kotek rozporowy uniwersalny z hakiem kątowym

#### Universal plug with hook



INDEX	ROZMIAR SIZE [mm]		ILOŚĆ [szt.] QUANTITY [pcs]		CENA / PRICE 1000 szt./pcs [PLN]
KS-06K	6 x 40	3,5	200	2400	438,00
KS-08K	8 x 50	4,5	100	1200	673,00

### Kotek rozporowy uniwersalny z hakiem sufitowym

#### Universal plug with ceiling hook



INDEX	ROZMIAR SIZE [mm]		ILOŚĆ [szt.] QUANTITY [pcs]		CENA / PRICE 1000 szt./pcs [PLN]
KS-06S	6 x 40	3,5	200	2400	510,00
KS-08S	8 x 50	4,5	100	1200	702,00

### Kotwa wbijana metalowa do płyt GK

#### Hammer-in fixing for plasterboard



INDEX	ROZMIAR SIZE [mm]							ILOŚĆ [szt.] QUANTITY [pcs]	CENA / PRICE 1000 szt./pcs [PLN]
	L	h	d <sub>1</sub>	L <sub>1</sub>	b	t <sub>max</sub>			
KG30	30	12	4,0	≥30	9÷13	L <sub>1</sub> -25	200	454,00	
KG40	40	12	4,0	≥40	13÷26	L <sub>1</sub> -35	100	542,00	
KG45G	43	18	4,0	≥50	13÷26	L <sub>1</sub> -40	100	1120,00	

Kotwy nie zawierają wkręta, rekomendowane zastosowanie wkrętów z serii UC40... lub UCT40...

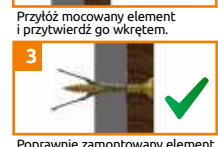
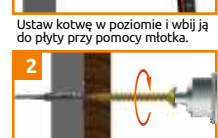
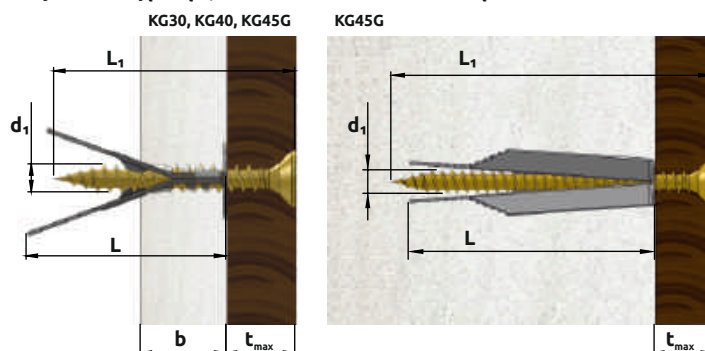

### Metalowy kołek rozporowy do gazobetonu

Metal universal plug for aerated concrete

AT-15-9757/2016 

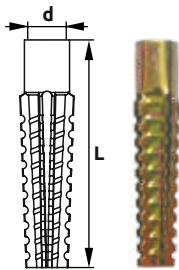

INDEX	ROZMIAR SIZE [mm]	Ø [mm]	ILOŚĆ [szt.] QUANTITY [pcs]	CENA / PRICE 1000 szt./pcs [PLN]
KRG-05030	5 x 30	4,5	200	155,00
KRG-06032	6 x 32	4,5 - 5,0	200	165,00
KRG-08038	8 x 38	5,0 - 6,0	200	215,00
KRG-08060	8 x 60	5,0 - 6,0	200	392,00
KRG-10060	10 x 60	6,0 - 8,0	200	410,00



### Kołek do gazobetonu

Universal plug for aerated concrete

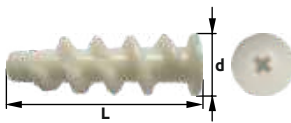

INDEX	ROZMIAR SIZE [mm]	Ø [mm]	ILOŚĆ [szt.] QUANTITY [pcs]	CENA / PRICE 1000 szt./pcs [PLN]
KGB	16 x 50	4,5	100	247,00

### Kołek stalowy typ "MOLLY"

Hollow wall anchor

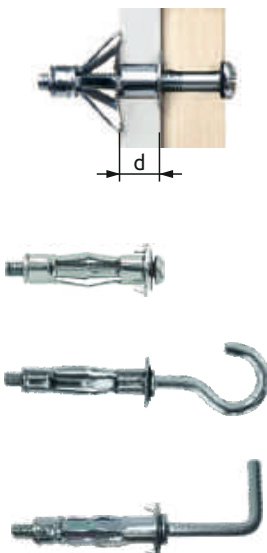

INDEX	ROZMIAR / SIZE [mm]	ILOŚĆ [szt.] QUANTITY [pcs]	CENA / PRICE 1000 szt./pcs [PLN]
SM-04020	M4 x 20	100	410,00
SM-04032	M4 x 32	100	415,00
SM-04038	M4 x 38	100	442,00
SM-04046	M4 x 46	100	465,00
SM-04059	M4 x 59	100	545,00
SM-04065	M4 x 65	100	641,00
SM-05037	M5 x 37	100	617,00
SM-05052	M5 x 52	100	650,00
SM-05065	M5 x 65	100	690,00
SM-06037	M6 x 37	100	700,00
SM-06052	M6 x 52	100	772,00
SM-06065	M6 x 65	100	820,00
SM-06080	M6 x 80	50	1 100,00
SM-08080	M8 x 80	50	1 154,00
SM-04032S	hak sufitowy / ceiling hook	100	750,00
SM-04032K	hak kątowy / hook	100	750,00
SM-05052S	hak sufitowy / ceiling hook	100	1 120,00
SM-05052K	hak kątowy / hook	100	1 120,00

### Ściągacz K2 do śrub typu „MOLLY”





Screw puller MOLLY



INDEX	ZAKRES PRACY OPERATING RANGES [mm]	ILOŚĆ [szt.] QUANTITY [pcs]	CENA / PRICE 1 szt./pcs [PLN]
AT-88	M4-M6	1	39,00
AT-88-1	M4-M6	1	45,00
AT-88-2	M4-M6	1	76,00
AT-88-3	M4-M8	1	32,00

## Kotek do zamocowań w ścianach gipsowo-kartonowych "DRIVA"

Driva pin for plaster walls

INDEX	MATERIAŁ MATERIAL	ROZMIAR SIZE [mm]		ILOŚĆ [szt.] QUANTITY [pcs]		CENA / PRICE 1000 szt./pcs [PLN]
						
DRIVA-01	Poliamid	14 x 40	3,5	200	4800	92,00
DRIVA-02	ZnAl	14 x 30	4,5	500	2000	555,00
DRIVA-03	ZnAl	14 x 40	4,0	100	-	672,00
DRIVA-04	ZnAl	14 x 40	M6	100	-	630,00
DRIVA-05	Poliamid	15 x 22	4,0	100	-	71,00



## Końcówka do wkrętarki DRIVA

Screwdriver bit for spit DRIVA

INDEX	ILOŚĆ [szt.] QUANTITY [pcs]	CENA / PRICE 1 szt./pcs [PLN]
DRIVA-KW	1	1,00



## Kotek rozporowy do pustych przestrzeni

Toggle anchor for empty spaces

INDEX	ROZMIAR SIZE [mm]	ILOŚĆ [szt.] QUANTITY [pcs]		CENA / PRICE 1000 szt./pcs [PLN]
				
08G (koszulka/plug)	8 x 40	100	1200	110,00
08GL (wkręt/screw)	8 x 40	100	1200	234,00
08GK (hak kątowy/hook)	8 x 40	100	1200	340,00
10G (koszulka/plug)	10 x 50	100	1200	93,00
10GL (wkręt/screw)	10 x 50	100	1200	135,00
10GK (hak kątowy/hook)	10 x 50	100	1200	330,00



## Kotwa sprężynowa do pustych przestrzeni

Toggle anchor for empty spaces, with screw

INDEX	ROZMIAR SIZE [mm]			Ø [mm]	ILOŚĆ [szt.] QUANTITY [pcs]		CENA / PRICE 1000 szt./pcs [PLN]
	d	L	d <sub>1</sub>				
SP-04BA	M4	-	22	14	100	1000	350,00
SP-05BA	M5	-	22	16	100	1000	380,00
SP-0450	M4	50	22	14	100	1000	680,00
SP-0580	M5	80	22	16	100	1000	835,00

## Kotwa sprężynowa do pustych przestrzeni z hakiem otwartym lub zamkniętym

Toggle anchor with ceiling hook, eyehook



INDEX	ROZMIAR SIZE [mm]					Ø [mm]	ILOŚĆ [szt.] QUANTITY [pcs]		CENA / PRICE 1000 szt./pcs [PLN]
	d	L	d <sub>1</sub>	s					
SP-0475o	M4	75	22	13	14	50	1000	930,00	
SP-0475z	M4	75	22	18	16	50	1000	1 020,00	
SP-0590o	M5	90	22	13	14	50	1000	1 350,00	
SP-0590z	M5	90	22	18	16	50	1000	1 400,00	

## Samowierzący wkręt do skręcania profili

Self drilling screws

PN-EN14566  
+ A1:2012 





INDEX	ROZMIAR SIZE [mm]	MAKSYMALNA PRZEWIERCALNOŚĆ DRILLING CAPACITY [mm]	ILOŚĆ [szt.] QUANTITY [pcs]		ILOŚĆ [szt./kg] QUANTITY [pcs/kg]	CENA / PRICE	
						1kg [PLN]	1000 szt./pcs [PLN]
WS-3911	3,9 x 11	2,50	1000	24000	855	20,00	26,00
WS-3595	3,5 x 9,5	2,50	1000	24000	1220	24,00	22,00
WS-3911bw	3,9 x 11	0,75	1000	24000	855	20,00	22,50
WS-3595oc	3,5 x 9,5	2,50	1000	24000	1220	24,00	21,50
WS-3911oc	3,9 x 11	2,50	1000	24000	855	20,00	26,00
WS-3911pcoc	3,9 x 11	2,50	1000	24000	1087	20,00	22,40

## Samowierzący wkręt do mocowania płyt gipsowych, maksymalna przewiercalność 2,25 mm

Drywall screws bugle head phillips coarse/ fine thread harden phosphated

PN-EN14566  
+ A1:2012 





INDEX	ROZMIAR SIZE [mm]	ILOŚĆ [szt.] QUANTITY [pcs]		ILOŚĆ [szt./kg] QUANTITY [pcs/kg]	CENA / PRICE	
					1kg [PLN]	1000 szt./pcs [PLN]
WS-3525	3,5 x 25	1000	24000	686	20,80	33,50
WS-3535	3,5 x 35	1000	12000	527	20,80	37,95
WS-3545	3,5 x 45	500	6000	412	20,80	45,50
WS-3555	3,5 x 55	500	6000	351	20,80	59,00

## Wkręt fosfatowany z gwintem do blachy

Drywall screws bugle head phillips coarse/ fine thread harden phosphated

PN-EN14566  
+ A1:2012 





INDEX	ROZMIAR SIZE [mm]	ILOŚĆ [szt.] QUANTITY [pcs]		ILOŚĆ [szt./kg] QUANTITY [pcs/kg]	CENA / PRICE	
					1kg [PLN]	1000 szt./pcs [PLN]
FS-3525	3,5 x 25	1000	24000	758	10,90	17,70
FS-3535	3,5 x 35	1000	12000	565	10,90	23,20
FS-3545	3,5 x 45	500	6000	459	10,90	29,60
FS-3555	3,5 x 55	500	6000	388	10,90	35,50
FS-4270	4,2 x 70	250	3000	227	10,90	61,00
FS-4890	4,8 x 90	200	2400	123	14,00	94,50
FS-48100	4,8 x 100	200	2400	113	14,50	123,50
FS-48120	4,8 x 120	200	2400	91	15,50	184,00

## Wkręt fosfatowany z gwintem do drewna

Drywall screws bugle head phillips coarse/ fine thread harden phosphated

PN-EN14566  
+ A1:2012 





INDEX	ROZMIAR SIZE [mm]	ILOŚĆ [szt.] QUANTITY [pcs]		ILOŚĆ [szt./kg] QUANTITY [pcs/kg]	CENA / PRICE	
					1kg [PLN]	1000 szt./pcs [PLN]
FT-3525	3,5 x 25	1000	24000	758	10,90	17,70
FT-3535	3,5 x 35	1000	12000	565	10,90	23,20
FT-3545	3,5 x 45	500	6000	459	10,90	29,60
FT-3555	3,5 x 55	500	6000	388	10,90	35,50
FT-4270	4,2 x 70	250	3000	227	10,90	61,00
FT-4890	4,8 x 90	200	2400	123	14,00	94,50
FT-48100	4,8 x 100	200	2400	113	14,50	123,50
FT-48110	4,8 x 110	200	2400	103	15,50	155,00
FT-48120	4,8 x 120	200	2400	91	15,50	184,00
FT-48140	4,8 x 140	200	2400	79	17,00	230,00
FT-48160	4,8 x 160	100	1200	62	19,00	320,00

## Wkręt fosfatowany z gwintem do drewna z tępym podkładkowym

Drywall screws bugle head phillips coarse/ fine thread harden phosphated

PN-EN14566  
+ A1:2012 



INDEX	ROZMIAR SIZE [mm]	ILOŚĆ [szt.] QUANTITY [pcs]		ILOŚĆ [szt./kg] QUANTITY [pcs/kg]	CENA / PRICE	
					1kg [PLN]	1000 szt./pcs [PLN]
FTP-4235	4,2 x 35	250	6000	758	33,90	49,20
FTP-4245	4,2 x 45	250	6000	565	33,90	61,30
FTP-4255	4,2 x 55	250	3000	459	33,90	85,00

### Kotek szybkiego montażu do wbijania, z lejkiem

Hammer drive plug with nail contersunk-type

AT-15-8327/2016



INDEX	ROZMIAR SIZE [mm]	ILOŚĆ [szt.] QUANTITY [pcs]		CENA / PRICE 1000 szt./pcs [PLN]
05L030	5 x 30	200	2400	75,00
05L040	5 x 40	200	2400	85,00
06L040	6 x 40	200	2400	51,90
06L060	6 x 60	100	1200	77,00
06L080	6 x 80	100	1200	104,00
08L045	8 x 45	100	1200	98,00
08L060	8 x 60	100	1200	119,00
08L080	8 x 80	100	1200	154,00
08L100	8 x 100	50	600	199,00
08L120	8 x 120	50	600	265,00
08L140	8 x 140	50	600	305,00
08L160	8 x 160	50	600	340,00
10L080	10 x 80	50	600	350,00
10L100	10 x 100	50	600	420,00
10L120	10 x 120	50	600	530,00
10L140	10 x 140	50	600	590,00
10L160	10 x 160	25	300	670,00
10L180	10 x 180	25	300	820,00
10L200	10 x 200	25	250	890,00

### Kotek szybkiego montażu do wbijania, z kotnierzem

Hammer drive plug with nail t-type

AT-15-8327/2016



INDEX	ROZMIAR SIZE [mm]	ILOŚĆ [szt.] QUANTITY [pcs]		CENA / PRICE 1000 szt./pcs [PLN]
06K040	6 x 40	200	2400	52,80
06K060	6 x 60	100	1200	82,00
06K080	6 x 80	100	1200	113,00
08K060	8 x 60	100	1200	129,50
08K080	8 x 80	100	1200	168,50
08K100	8 x 100	50	600	218,00

### Metalowy kotek do wbijania

Zinc alloy nail in anchor

AT-15-9757/2016

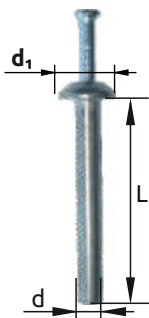

INDEX	ROZMIAR SIZE [mm]			ILOŚĆ [szt.] QUANTITY [pcs]		CENA / PRICE 1000 szt./pcs [PLN]
	d	L	d <sub>1</sub>			
KMW-05020	5	20	12	100	2400	290,00
KMW-06030	6	30	12	100	2400	380,00
KMW-06040	6	40	12	100	2400	410,00
KMW-06050	6	50	12	100	1200	506,00
KMW-06065	6	65	12	100	1200	650,00

### Kotwa rozprężna wbijana do montażu sufitów podwieszanych

Hammer drive in anchor for suspended ceilings

AT-15-9757/2016

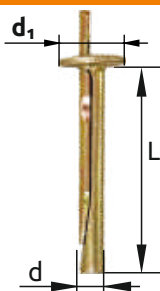

INDEX	ROZMIAR SIZE [mm]			ILOŚĆ [szt.] QUANTITY [pcs]		CENA / PRICE 1000 szt./pcs [PLN]
	d	L	d <sub>1</sub>			
GS-06035	6	35	14	100	1200	540,00
GS-06065	6	65	14	100	1200	930,00

## Kotek z długą płaszczyzną podziału z wkrętem z łbem stożkowym

Frame fixing with countersunk head screw



INDEX	ROZMIAR SIZE [mm]		ILOŚĆ [szt.] QUANTITY [pcs]	CENA / PRICE 1 szt./pcs [PLN]
PX-10100	10 x 100	6 x 100	50	0,62
PX-10120	10 x 120	6 x 120	50	0,74
PX-10140	10 x 140	6 x 140	50	1,16
PX-10160	10 x 160	6 x 160	50	1,38
PX-10180	10 x 180	6 x 180	50	1,70
PX-10200	10 x 200	6 x 200	50	2,12
PX-10220	10 x 220	6 x 220	50	4,62
PX-10240	10 x 240	6 x 240	50	5,36
PX-10260	10 x 260	6 x 260	50	6,10
PX-10280	10 x 280	6 x 280	50	6,84
PX-10300	10 x 300	6 x 300	50	7,60
PX-12100	12 x 100	8 x 100	50	1,06
PX-12120	12 x 120	8 x 120	50	1,18
PX-12140	12 x 140	8 x 140	50	1,72
PX-12160	12 x 160	8 x 160	50	2,36
PX-12180	12 x 180	8 x 180	50	2,89
PX-12200	12 x 200	8 x 200	50	3,44

## Kotek z długą płaszczyzną podziału z wkrętem z łbem sześciokątnym

Frame fixing with hexagonal head screw



INDEX	ROZMIAR SIZE [mm]		ILOŚĆ [szt.] QUANTITY [pcs]	CENA / PRICE 1 szt./pcs [PLN]
PK-10100	10 x 100	6 x 100	50	0,62
PK-10120	10 x 120	6 x 120	50	0,74
PK-10140	10 x 140	6 x 140	50	1,16
PK-10160	10 x 160	6 x 160	50	1,38
PK-10180	10 x 180	6 x 180	50	1,70
PK-10200	10 x 200	6 x 200	50	2,12
PK-10220	10 x 220	6 x 220	50	3,04
PK-10240	10 x 240	6 x 240	50	3,73
PK-10260	10 x 260	6 x 260	50	4,20
PK-10280	10 x 280	6 x 280	50	4,40
PK-10300	10 x 300	6 x 300	50	4,76
PK-12100	12 x 100	8 x 100	50	0,74
PK-12120	12 x 120	8 x 120	50	0,89
PK-12140	12 x 140	8 x 140	50	1,20
PK-12160	12 x 160	8 x 160	50	1,64
PK-12180	12 x 180	8 x 180	50	2,00
PK-12200	12 x 200	8 x 200	50	2,40
PK-12220	12 x 220	8 x 220	50	3,37
PK-12240	12 x 240	8 x 240	50	4,14
PK-12260	12 x 260	8 x 260	25	4,66
PK-12280	12 x 280	8 x 280	25	4,89
PK-12300	12 x 300	8 x 300	25	5,29
PK-12320	12 x 320	8 x 320	25	6,67
PK-12340	12 x 340	8 x 340	25	9,58
PK-12360	12 x 360	8 x 360	25	10,17
PK-16100	16 x 100	12 x 100	25	2,45
PK-16120	16 x 120	12 x 120	25	2,80
PK-16140	16 x 140	12 x 140	25	3,20
PK-16160	16 x 160	12 x 160	25	3,66
PK-16180	16 x 180	12 x 180	25	4,00
PK-16200	16 x 200	12 x 200	25	4,45
PK-16220	16 x 220	12 x 220	25	5,35
PK-16260	16 x 260	12 x 260	25	6,55
PK-16300	16 x 300	12 x 300	25	7,60

## Kotek z długą płaszczyzną podziału z hakiem sufitowym

Frame fixing with ceiling hook



INDEX	ROZMIAR SIZE [mm]		ILOŚĆ [szt.] QUANTITY [pcs]	CENA / PRICE 1 szt./pcs [PLN]
PKS-10100	10 x 100	6 x 100	50	0,77
PKS-10120	10 x 120	6 x 120	50	0,90
PKS-10140	10 x 140	6 x 140	50	1,09
PKS-10160	10 x 160	6 x 160	50	1,34
PKS-10180	10 x 180	6 x 180	50	1,63
PKS-10200	10 x 200	6 x 200	50	2,05
PKS-12100	12 x 100	8 x 100	50	1,31
PKS-12120	12 x 120	8 x 120	50	1,45
PKS-12140	12 x 140	8 x 140	50	1,65
PKS-12160	12 x 160	8 x 160	50	1,78
PKS-12180	12 x 180	8 x 180	50	1,98
PKS-12200	12 x 200	8 x 200	50	2,20

## Kotek z długą płaszczyzną podziału z hakiem prostym

Frame fixing with hook



INDEX	ROZMIAR SIZE [mm]		ILOŚĆ [szt.] QUANTITY [pcs]	CENA / PRICE 1 szt./pcs [PLN]
PKH-10100	10 x 100	6 x 100	50	0,66
PKH-10120	10 x 120	6 x 120	50	0,76
PKH-10140	10 x 140	6 x 140	50	1,16
PKH-10160	10 x 160	6 x 160	50	1,38
PKH-10180	10 x 180	6 x 180	50	1,79
PKH-10200	10 x 200	6 x 200	50	2,08
PKH-12100	12 x 100	8 x 100	50	1,00
PKH-12120	12 x 120	8 x 120	50	1,11
PKH-12140	12 x 140	8 x 140	50	1,29
PKH-12160	12 x 160	8 x 160	50	1,62
PKH-12180	12 x 180	8 x 180	50	1,91
PKH-12200	12 x 200	8 x 200	50	2,22

## Koszulka kotka z długą płaszczyzną podziału

Frame plug

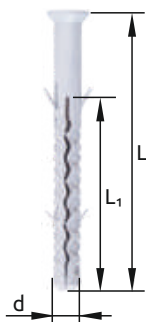

INDEX	ROZMIAR SIZE [mm]			ILOŚĆ [szt.] QUANTITY [pcs]	CENA / PRICE 1000 szt./pcs [PLN]
	d	L	L <sub>1</sub>		
KRK-08080	8	80	60	100	130,00
KRK-08100	8	100	60	100	150,00
KRK-08120	8	120	60	100	175,00
KRK-08140	8	140	60	100	195,00
KRK-08160	8	160	60	100	211,00
KRK-10080	10	80	60	50	172,00
KRK-10100	10	100	60	50	196,00
KRK-10120	10	120	60	50	220,00
KRK-10140	10	140	60	50	255,00
KRK-10160	10	160	60	50	332,00
KRK-10180	10	180	60	50	389,00
KRK-10200	10	200	60	50	441,00

## Kotek z długą płaszczyzną podziału z wkrętem z łbem sześciokątnym

Frame fixing with hexagonal head screw



INDEX	ROZMIAR SIZE [mm]		ILOŚĆ [szt.] QUANTITY [pcs]	CENA / PRICE 1000 szt./pcs [PLN]
KR-08080	8 x 80	5,0 x 85	50	330,00
KR-08100	8 x 100	5,0 x 105	50	385,00
KR-08120	8 x 120	5,0 x 125	50	475,00
KR-08140	8 x 140	5,0 x 145	50	530,00
KR-08160	8 x 160	5,0 x 165	50	650,00
KR-10080	10 x 80	6,8 x 85	50	670,00
KR-10100	10 x 100	6,8 x 100	50	710,00
KR-10120	10 x 120	6,8 x 125	50	800,00
KR-10140	10 x 140	6,8 x 145	50	1 160,00
KR-10160	10 x 160	6,8 x 165	50	1 380,00
KR-10180	10 x 180	6,8 x 185	50	1 700,00
KR-10200	10 x 200	6,8 x 205	50	2 120,00

## Kotek z długą płaszczyzną podziału z wkrętem z łbem stożkowym typu POZIDRIVE

Frame fixing with screw





INDEX	ROZMIAR SIZE [mm]		ILOŚĆ [szt.] QUANTITY [pcs]	CENA / PRICE 1000 szt./pcs [PLN]
KRD-08080	8 x 80	5,0 x 85	50	350,00
KRD-08100	8 x 100	5,0 x 105	50	415,00
KRD-08120	8 x 120	5,0 x 125	50	487,00
KRD-08140	8 x 140	5,0 x 145	50	592,00
KRD-08160	8 x 160	5,0 x 165	50	570,00
KRD-10080	10 x 80	6,8 x 85	50	590,00
KRD-10100	10 x 100	6,8 x 100	50	630,00
KRD-10120	10 x 120	6,8 x 125	50	740,00
KRD-10140	10 x 140	6,8 x 145	50	1 160,00
KRD-10160	10 x 160	6,8 x 165	50	1 380,00
KRD-10180	10 x 180	6,8 x 185	50	1 700,00
KRD-10200	10 x 200	6,8 x 205	50	2 120,00

**Wkręt hartowany do drewna, płyt wiórowych i PCV (gniazdo PZ, TORX)**  
Chipboard screws countersunk flat

PN-EN 14592+A1:2012 



INDEX	ROZMIAR SIZE [mm]	ILOŚĆ [szt.] QUANTITY [pcs]		ILOŚĆ [szt./kg] QUANTITY [pcs/kg]	CENA / PRICE	
					1000 szt./pcs [ PLN ]	1kg (box 10kg) [ PLN ]
UC-2512 ***	2,5 x 12	1000	24000	3030	11,99	23,78
UC-2516	2,5 x 16	1000	24000	2500	13,97	23,78
UC-2520	2,5 x 20	1000	24000	2220	16,06	19,89
UC-3012 ***	3,0 x 12	1000	24000	2270	12,43	19,89
UC-3016	3,0 x 16	1000	24000	1920	14,08	19,89
UC-3020	3,0 x 20	1000	24000	1470	16,06	19,89
UC-3025	3,0 x 25	1000	12000	1330	17,93	19,19
UC-3030	3,0 x 30	1000	12000	1100	20,13	19,19
UC-3035	3,0 x 35	1000	12000	900	21,78	18,83
UC-3040	3,0 x 40	1000	12000	770	25,30	17,36
UC-3512 ***	3,5 x 12	1000	24000	1630	13,97	15,50
UC-3516 ***	3,5 x 16	1000	24000	1400	15,62	15,50
UC-3520	3,5 x 20	1000	12000	1190	17,27	15,50
UC-3525	3,5 x 25	1000	12000	910	20,46	15,50
UC-3530	3,5 x 30	1000	12000	820	23,87	15,50
UC-3535	3,5 x 35	1000	12000	700	26,84	15,50
UC-3540 **	3,5 x 40	1000	12000	615	30,68	15,50
UC-3545 **	3,5 x 45	500	6000	550	31,16	15,50
UC-3550 **	3,5 x 50	500	6000	515	35,96	15,50
UC-3560 **	3,5 x 60	500	6000	450	38,70	15,50
UC-4012 ***	4,0 x 12	1000	24000	1380	17,05	15,50
UC-4016 ***	4,0 x 16	1000	24000	1000	19,47	15,50
UC-4020 ***	4,0 x 20	1000	12000	805	22,44	15,50
UC-4025	4,0 x 25	1000	12000	705	26,40	15,50
UC-4030	4,0 x 30	500	6000	606	30,03	15,28
UC-4035	4,0 x 35	500	6000	520	33,88	15,28
UC-4040 **	4,0 x 40	500	6000	460	37,84	15,28
UC-4045 **	4,0 x 45	500	6000	420	42,15	15,28
UC-4050 **	4,0 x 50	500	6000	380	46,09	15,28
UC-4060 **	4,0 x 60	500	6000	340	56,98	15,28
UC-4070 *	4,0 x 70	250	3000	290	67,45	15,28
UC-4080 *	4,0 x 80	250	3000	240	74,34	15,28
UC-4516 ***	4,5 x 16	500	12000	750	24,20	15,28
UC-4520 ***	4,5 x 20	500	12000	650	30,25	15,28
UC-4525	4,5 x 25	500	6000	560	32,45	15,28
UC-4530	4,5 x 30	500	6000	470	36,96	15,17
UC-4535	4,5 x 35	500	6000	420	42,24	15,17
UC-4540	4,5 x 40	500	6000	360	46,75	15,17
UC-4545	4,5 x 45	500	6000	325	51,59	15,17
UC-4550 **	4,5 x 50	500	3000	310	55,99	15,17
UC-4560 **	4,5 x 60	250	3000	250	67,87	15,17
UC-4570 *	4,5 x 70	250	3000	220	84,70	15,17
UC-4580 *	4,5 x 80	250	3000	195	116,49	15,17

\* wkręt z niepełnym gwintem

\*\* wkręt występuje w dwóch wariantach - pełny i niepełny gwint



\*\*\* nie do zastosowań konstrukcyjnych

## Wkręt hartowany do drewna, płyt wiórowych i PCV (gniazdo PZ, TORX)

Chipboard screws countersunk flat

PN-EN 14592+A1:2012 



INDEX	ROZMIAR SIZE [mm]	ILOŚĆ [szt.] QUANTITY [pcs]		ILOŚĆ [szt./kg] QUANTITY [pcs/kg]	CENA / PRICE	
					1000 szt./pcs [PLN]	1kg (box 10kg) [PLN]
UC-5020 ***	5,0 x 20	500	6000	495	36,41	15,17
UC-5025	5,0 x 25	500	6000	420	41,58	15,17
UC-5030	5,0 x 30	500	6000	380	46,97	15,17
UC-5035	5,0 x 35	500	6000	320	52,80	15,17
UC-5040	5,0 x 40	500	6000	280	57,09	15,17
UC-5045	5,0 x 45	500	6000	260	62,48	15,17
UC-5050 **	5,0 x 50	500	6000	242	67,87	15,17
UC-5060 **	5,0 x 60	250	3000	205	83,82	15,17
UC-5070 *	5,0 x 70	250	3000	175	98,34	15,17
UC-5080 *	5,0 x 80	200	2400	156	133,76	15,17
UC-5090 *	5,0 x 90	200	2400	142	155,22	15,17
UC-5100 *	5,0 x 100	200	2400	126	175,45	15,17
UC-5110 *	5,0 x 110	100	1200	117	199,21	15,17
UC-5120 *	5,0 x 120	100	1200	108	222,97	15,17
UC-6030	6,0 x 30	250	3000	235	73,04	15,17
UC-6040	6,0 x 40	250	3000	200	87,01	15,17
UC-6045	6,0 x 45	250	3000	181	104,20	15,17
UC-6050	6,0 x 50	250	3000	160	114,07	15,17
UC-6060	6,0 x 60	250	3000	137	124,74	15,17
UC-6070 **	6,0 x 70	200	2400	116	139,28	15,17
UC-6080 *	6,0 x 80	200	2400	103	165,99	15,17
UC-6090 *	6,0 x 90	100	1200	94	187,55	15,17
UC-6100 *	6,0 x 100	100	1200	84	211,97	15,17
UC-6110 *	6,0 x 110	100	1200	78	239,08	15,17
UC-6120 *	6,0 x 120	100	1200	72	266,20	15,50
UC-6130 *	6,0 x 130	100	1200	66	301,29	17,00
UC-6140 *	6,0 x 140	100	1200	62	325,88	17,00
UC-6150 *	6,0 x 150	100	1200	58	433,10	17,00
UC-6160 *	6,0 x 160	100	1200	51	535,20	17,00
UC-6180 *	6,0 x 180	100	1200	42	649,15	18,30
UC-6200 * <sup>TX</sup>	6,0 x 200	100	1200	38	756,80	18,30
UC-6220 * <sup>TX</sup>	6,0 x 220	100	1000	35	955,35	26,00
UC-6240 * <sup>TX</sup>	6,0 x 240	100	1000	33	1 013,00	28,00
UC-6260 * <sup>TX</sup>	6,0 x 260	100	1000	31	1 100,00	30,00

\* wkręt z niepełnym gwintem  
 \*\* wkręt występuje w dwóch wariantach - pełny i niepełny gwint  
 \*\*\* nie do zastosowań konstrukcyjnych  
<sup>TX</sup> wkręt z gniazdem TORX-30

## Wkręt tarasowy A4 TORX T20

Terrace screw



INDEX	ROZMIAR SIZE [mm]	MATERIAŁ MATERIAL	ILOŚĆ [szt.] QUANTITY [pcs]	CENA / PRICE opakowanie / box [PLN]
WTN4245INO	4,2 x 45	INOX	250	91,80
WTN4255INO	4,2 x 55	INOX	250	111,19
WTN4875INO	4,8 x 75	INOX	100	76,20

**Wkręt z tłem talerzowym do drewna i płyt wiórowych - ocynkowany**  
 Construction flange head screw

PN-EN 14592+A1:2012

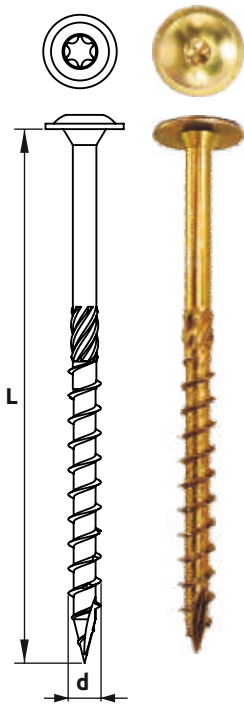

INDEX	ROZMIAR d x L SIZE d x L [mm]	ILOŚĆ [szt.] QUANTITY [pcs]		Gniazdo NEST	CENA / PRICE 1000 szt./pcs [PLN]
UCSP-06030 ***	6 x 30	100	1800	TORX 30	231,98
UCSP-06040	6 x 40	100	1800	TORX 30	273,97
UCSP-06050	6 x 50	100	1800	TORX 30	316,20
UCSP-06060	6 x 60	100	1800	TORX 30	342,70
UCSP-06070	6 x 70	100	1800	TORX 30	373,90
UCSP-06080	6 x 80	100	1800	TORX 30	384,22
UCSP-06100	6 x 100	100	1000	TORX 30	436,12
UCSP-06120	6 x 120	100	1000	TORX 30	574,63
UCSP-06140	6 x 140	100	1000	TORX 30	691,38
UCSP-06160	6 x 160	100	1000	TORX 30	870,77
UCSP-06180	6 x 180	100	1000	TORX 30	1591,47
UCSP-06200	6 x 200	100	1000	TORX 30	1710,40
UCSP-06220	6 x 220	100	1000	TORX 30	2128,32
UCSP-06240	6 x 240	100	1000	TORX 30	2701,67
UCSP-06260	6 x 260	100	800	TORX 30	2904,55
UCSP-06280	6 x 280	50	400	TORX 30	3245,45
UCSP-06300	6 x 300	50	400	TORX 30	3456,70
UCSP-08060 ***	8 x 60	50	400	TORX 40	534,00
UCSP-08080	8 x 80	50	400	TORX 40	560,00
UCSP-08100	8 x 100	50	400	TORX 40	576,00
UCSP-08120	8 x 120	50	400	TORX 40	689,52
UCSP-08140	8 x 140	50	400	TORX 40	824,68
UCSP-08160	8 x 160	50	400	TORX 40	1001,32
UCSP-08180	8 x 180	50	400	TORX 40	1256,68
UCSP-08200	8 x 200	50	400	TORX 40	1423,90
UCSP-08220	8 x 220	50	400	TORX 40	1686,67
UCSP-08240	8 x 240	50	400	TORX 40	1838,97
UCSP-08260	8 x 260	50	400	TORX 40	2148,20
UCSP-08280	8 x 280	50	400	TORX 40	2388,23
UCSP-08300	8 x 300	50	400	TORX 40	2797,48
UCSP-08320	8 x 320	50	400	TORX 40	3795,83
UCSP-08340	8 x 340	50	400	TORX 40	4141,67
UCSP-08360	8 x 360	50	400	TORX 40	4671,45
UCSP-08380	8 x 380	50	400	TORX 40	5124,34
UCSP-08400	8 x 400	50	400	TORX 40	5649,95
UCSP-10080	10 x 80	50	500	TORX 40	1103,33
UCSP-10100	10 x 100	50	500	TORX 40	1345,79
UCSP-10120	10 x 120	50	500	TORX 40	1710,87
UCSP-10140	10 x 140	50	500	TORX 40	1999,75
UCSP-10160	10 x 160	50	500	TORX 40	2286,37
UCSP-10180	10 x 180	50	500	TORX 40	2617,42
UCSP-10200	10 x 200	50	500	TORX 40	2946,25
UCSP-10220	10 x 220	50	500	TORX 40	3288,46
UCSP-10240	10 x 240	25	200	TORX 40	3666,17
UCSP-10260	10 x 260	25	200	TORX 40	4060,58
UCSP-10280	10 x 280	25	200	TORX 40	4513,79
UCSP-10300	10 x 300	25	200	TORX 40	5082,92
UCSP-10320	10 x 320	25	200	TORX 40	5344,32
UCSP-10340	10 x 340	25	200	TORX 40	5874,45
UCSP-10360	10 x 360	25	200	TORX 40	6343,31
UCSP-10380	10 x 380	25	200	TORX 40	6976,23
UCSP-10400	10 x 400	25	200	TORX 40	8432,20

\*\*\* nie do zastosowań konstrukcyjnych

## Wkręt z łbem stożkowym do drewna i płyt wiórowych - ocynkowany

Construction flat head screw

PN-EN 14592+A1:2012 

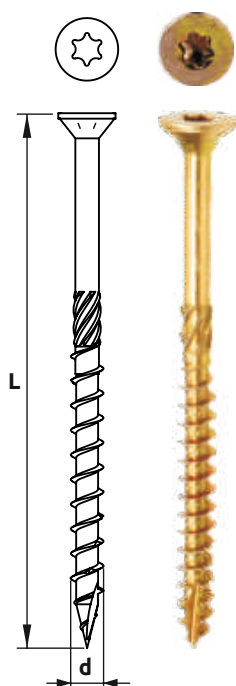

INDEX	ROZMIAR d x L SIZE d x L [mm]	ILOŚĆ [szt.] QUANTITY [pcs]	GNAZDO NEST	CENA / PRICE	
				1000 szt./pcs [PLN]	1kg (box 10kg) [PLN]
UCT-3012 ***	3,0 x 12	1500	TORX-10	16,81	-
UCT-3016 ***	3,0 x 16	1500	TORX-10	18,59	-
UCT-3020 ***	3,0 x 20	1500	TORX-10	20,48	-
UCT-3025 ***	3,0 x 25	1500	TORX-10	22,73	-
UCT-3030 ***	3,0 x 30	1500	TORX-10	24,62	-
UCT-3035 ***	3,0 x 35	1500	TORX-10	27,23	-
UCT-3040 ***	3,0 x 40	1500	TORX-10	29,95	-
UCT-3530	3,5 x 30	1000	TORX-15	34,09	23,33
UCT-3535	3,5 x 35	1000	TORX-15	37,91	23,33
UCT-3540	3,5 x 40	1000	TORX-15	40,97	23,33
UCT-3550	3,5 x 50	500	TORX-15	49,03	23,33
UCT-4030	4,0 x 30	500	TORX-20	38,33	21,67
UCT-4035	4,0 x 35	500	TORX-20	41,85	21,67
UCT-4040	4,0 x 40	500	TORX-20	46,39	21,67
UCT-4045	4,0 x 45	500	TORX-20	52,00	21,67
UCT-4050	4,0 x 50	500	TORX-20	56,06	21,67
UCT-4060	4,0 x 60	500	TORX-20	67,00	21,67
UCT-4070	4,0 x 70	250	TORX-20	79,00	21,67
UCT-4535	4,5 x 35	500	TORX-25	51,82	21,67
UCT-4540	4,5 x 40	500	TORX-25	59,12	21,67
UCT-4545	4,5 x 45	500	TORX-25	64,24	21,67
UCT-4550	4,5 x 50	250	TORX-25	68,36	21,67
UCT-4560	4,5 x 60	250	TORX-25	81,52	21,67
UCT-4570	4,5 x 70	250	TORX-25	95,42	21,67
UCT-4580	4,5 x 80	250	TORX-25	107,73	21,67
UCT-5040	5,0 x 40	500	TORX-25	71,00	21,67
UCT-5045	5,0 x 45	500	TORX-25	74,64	21,67
UCT-5050	5,0 x 50	500	TORX-25	88,00	21,67
UCT-5060	5,0 x 60	250	TORX-25	103,00	21,67
UCT-5070	5,0 x 70	250	TORX-25	117,00	21,67
UCT-5080	5,0 x 80	200	TORX-25	132,00	21,67
UCT-5090	5,0 x 90	200	TORX-25	144,00	21,67
UCT-5100	5,0 x 100	200	TORX-25	159,00	21,67
UCT-5120	5,0 x 120	100	TORX-25	235,36	21,67
UCT-6050	6,0 x 50	250	TORX-30	127,00	20,83
UCT-6060	6,0 x 60	250	TORX-30	152,00	20,83
UCT-6070	6,0 x 70	200	TORX-30	175,00	20,83
UCT-6080	6,0 x 80	200	TORX-30	203,00	20,83
UCT-6090	6,0 x 90	100	TORX-30	217,00	20,83
UCT-6100	6,0 x 100	100	TORX-30	246,50	20,83
UCT-6120	6,0 x 120	100	TORX-30	326,97	20,83
UCT-6130	6,0 x 130	100	TORX-30	384,06	20,83
UCT-6140	6,0 x 140	100	TORX-30	411,00	20,83
UCT-6150	6,0 x 150	100	TORX-30	499,24	25,00
UCT-6160	6,0 x 160	100	TORX-30	559,39	25,00
UCT-6180	6,0 x 180	100	TORX-30	632,30	25,00
UCT-6200	6,0 x 200	100	TORX-30	776,20	25,00
UCT-6220	6,0 x 220	100	TORX-30	840,00	25,00
UCT-6240	6,0 x 240	100	TORX-30	978,00	26,67
UCT-6260	6,0 x 260	100	TORX-30	1 202,00	28,33
UCT-6280	6,0 x 280	100	TORX-30	1 459,00	28,33
UCT-6300	6,0 x 300	100	TORX-30	1 678,00	30,00

\*\*\* nie do zastosowań konstrukcyjnych

**Wkręt z tłem stożkowym do drewna i płyt wiórowych - ocynkowany**  
 Construction flat head screw

PN-EN 14592+A1:2012

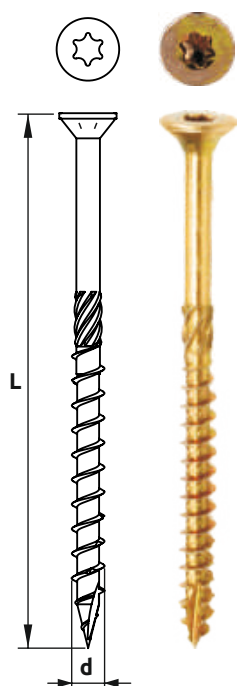

INDEX	ROZMIAR d x L SIZE d x L [mm]		ILOŚĆ [szt.] QUANTITY [pcs]	GNAZDO NEST	CENA / PRICE	
					1000 szt./pcs [PLN]	1kg (box 10kg) [PLN]
UCT-8080	8,0	80	50	TORX-40	588,12	21,67
UCT-8100	8,0	100	50	TORX-40	712,79	21,67
UCT-8120	8,0	120	50	TORX-40	924,87	21,67
UCT-8140	8,0	140	50	TORX-40	1 093,25	21,67
UCT-8160	8,0	160	50	TORX-40	1 307,75	21,67
UCT-8180	8,0	180	50	TORX-40	1 460,92	26,67
UCT-8200	8,0	200	50	TORX-40	1 813,21	26,67
UCT-8220	8,0	220	50	TORX-40	2 082,66	30,00
UCT-8240	8,0	240	50	TORX-40	2 313,87	30,00
UCT-8260	8,0	260	50	TORX-40	2 599,58	30,00
UCT-8280	8,0	280	50	TORX-40	2 853,33	30,00
UCT-8300	8,0	300	50	TORX-40	3 198,29	30,00
UCT-8320	8,0	320	50	TORX-40	3 640,12	30,00
UCT-8340	8,0	340	50	TORX-40	3 938,21	33,33
UCT-8360	8,0	360	50	TORX-40	4 134,24	33,33
UCT-8380	8,0	380	50	TORX-40	4 958,48	33,33
UCT-8400	8,0	400	50	TORX-40	6 052,52	33,33
UCT-10100	10,0	100	50	TORX-40	1 790,70	-
UCT-10120	10,0	120	50	TORX-40	2 015,66	-
UCT-10140	10,0	140	50	TORX-40	2 215,45	-
UCT-10160	10,0	160	50	TORX-40	2 515,52	-
UCT-10180	10,0	180	50	TORX-40	3 074,69	-
UCT-10200	10,0	200	50	TORX-40	4 050,90	-
UCT-10220	10,0	220	50	TORX-40	4 740,04	-
UCT-10240	10,0	240	50	TORX-40	5 370,06	-
UCT-10260	10,0	260	50	TORX-40	5 707,62	-
UCT-10280	10,0	280	50	TORX-40	6 787,30	-
UCT-10300	10,0	300	25	TORX-40	7 529,96	-
UCT-10320	10,0	320	25	TORX-40	8 477,08	-
UCT-10340	10,0	340	25	TORX-40	9 380,10	-
UCT-10360	10,0	360	25	TORX-40	10 301,82	-
UCT-10380	10,0	380	25	TORX-40	11 144,24	-
UCT-10400	10,0	400	25	TORX-40	11 794,62	-

**Wkręt hartowany do mocowania ościeżnic z tłem stożkowym/walcowym TORX 30**  
 Concrete screw

ITB-KOT-2017/0095 wyd. 1

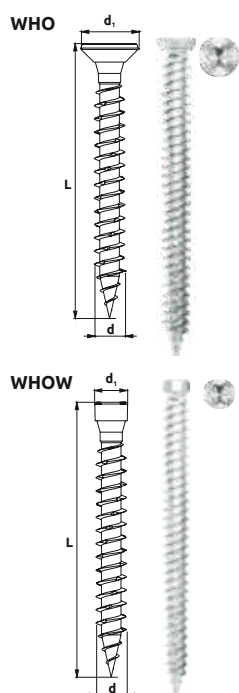

INDEX	ROZMIAR SIZE [mm]			ILOŚĆ [szt.] QUANTITY [pcs]		GNAZDO NEST	CENA / PRICE 1000 szt./pcs [PLN]
	d	L	d <sub>1</sub>				
WHO-75052	7,5	52	11,0	100	1200	TORX-30	276,00
WHO-75072	7,5	72	11,0	100	800	TORX-30	314,00
WHO-75092	7,5	92	11,0	100	800	TORX-30	371,00
WHO-75112	7,5	112	11,0	100	800	TORX-30	534,00
WHO-75132	7,5	132	11,0	100	800	TORX-30	620,00
WHO-75152	7,5	152	11,0	100	600	TORX-30	795,00
WHO-75182	7,5	182	11,0	100	400	TORX-30	1 150,00
WHO-75202	7,5	202	11,0	100	400	TORX-30	1 200,00
WHO-75212	7,5	212	11,0	100	400	TORX-30	1 350,00
WHOW-75052	7,5	52	8,3	100	1200	TORX-30	276,00
WHOW-75072	7,5	72	8,3	100	800	TORX-30	314,00
WHOW-75092	7,5	92	8,3	100	800	TORX-30	371,00
WHOW-75112	7,5	112	8,3	100	800	TORX-30	534,00
WHOW-75132	7,5	132	8,3	100	800	TORX-30	620,00
WHOW-75152	7,5	152	8,3	100	600	TORX-30	795,00
WHOW-75182	7,5	182	8,3	100	400	TORX-30	1 150,00
WHOW-75202	7,5	202	8,3	100	400	TORX-30	1 200,00
WHOW-75212	7,5	212	8,3	100	400	TORX-30	1 350,00

## Kotwa stalowa do ościeżnic

Metal frame anchor

ITB-KOT-2017/0094 wyd. 1 

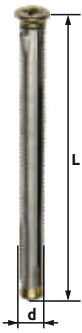

INDEX	ROZMIAR d x L SIZE d x L [mm]	ILOŚĆ [szt.] QUANTITY [pcs]	GNAZDO NEST	CENA / PRICE 1000 szt./pcs [PLN]
O-10072	10 x 72	100	PZ-3	470,00
O-10092	10 x 92	100	PZ-3	565,00
O-10112	10 x 112	100	PZ-3	670,00
O-10132	10 x 132	100	PZ-3	760,00
O-10152	10 x 152	100	PZ-3	841,00
O-10182	10 x 182	100	PZ-3	1 023,00
O-10202	10 x 202	100	PZ-3	1 120,00

## Kotwa stalowa do ościeżnic „KOMBI”

Metal frame anchor

ITB-KOT-2017/0094 wyd. 1 

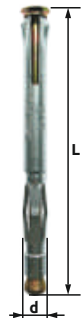

INDEX	ROZMIAR d x L SIZE d x L [mm]	ILOŚĆ [szt.] QUANTITY [pcs]	GNAZDO NEST	CENA / PRICE 1 szt./pcs [PLN]
O-112 K	10 x 112	100	PZ-3	0,92
O-132 K	10 x 132	100	PZ-3	1,04
O-152 K	10 x 152	100	PZ-3	1,14
O-182 K	10 x 182	100	PZ-3	1,41
O-202 K	10 x 202	100	PZ-3	1,53

## Wkręt samowiertny do stolarki PCV

Windows buliding self-drilling screws



INDEX	ROZMIAR SIZE [mm]	GNAZDO NEST	ILOŚĆ [szt.] QUANTITY [pcs]	CENA / PRICE 1000 szt./pcs [PLN]
KS-3913	3,9 x 13	PH-2	1000	21,00
KS-3916	3,9 x 16	PH-2	1000	26,50
KS-3919	3,9 x 19	PH-2	1000	32,00
KS-3925	3,9 x 25	PH-2	1000	37,50
KS-3932	3,9 x 32	PH-2	1000	45,00
KS-3938	3,9 x 38	PH-2	1000	61,00

## Wkręt do montażu okuć z tłem stożkowym

Windows buliding self-taping screws



INDEX	ROZMIAR SIZE [mm]	GNAZDO NEST	ILOŚĆ [szt.] QUANTITY [pcs]	CENA / PRICE 1000 szt./pcs [PLN]
KSO-4020	4,0 x 20	PH-2	1000	24,00
KSO-4025	4,0 x 25	PH-2	1000	30,00
KSO-4030	4,0 x 30	PH-2	500	36,00
KSO-4035	4,0 x 35	PH-2	500	41,00
KSO-4040	4,0 x 40	PH-2	500	48,00

## Wkręt do cienkich blach z tłem stożkowym, ze skrzydełkami

Self drilling screws with wings

ITB-KOT-2019/0761 wyd. 1 



INDEX	ROZMIAR SIZE [mm]	GNAZDO NEST	MAKSYMALNA PRZEWIERCALNOŚĆ DRILLING CAPACITY [mm]	ILOŚĆ [szt.] QUANTITY [pcs]	CENA / PRICE 1000 szt./pcs [PLN]
KSS-4832	4,8 x 32	TX-25	2,5	500	93,50
KSS-4838	4,8 x 38	TX-25	2,5	500	96,50
KSS-4845	4,8 x 45	TX-25	2,5	500	112,50
KSS-4855	4,8 x 55	TX-25	2,5	500	129,00
KSS-5538	5,5 x 38	TX-25	4,5	250	130,00
KSS-5545	5,5 x 45	TX-25	4,5	250	149,00
KSS-5550	5,5 x 50	TX-25	4,5	250	178,00
KSS-5555	5,5 x 55	TX-25	4,5	250	186,00
KSS-5570	5,5 x 70	TX-25	4,5	200	212,00
KSS-6350	6,3 x 50	TX-30	6,0	200	230,00
KSS-6360	6,3 x 60	TX-30	6,0	200	290,00
KSS-6370	6,3 x 70	TX-30	6,0	200	310,00

## Zaślepka do wkrętów

Plastic cap



INDEX	ZASTOSOWANIE APPLICATION	CENA / PRICE 1000 szt./pcs [ PLN ]
ZWS	Zaślepka do wkrętów - typ konfirmat	25,00
ZWP2	Zaślepka do wkrętów - typ PZ2	25,00
ZWP3	Zaślepka do wkrętów - typ PZ3	25,00
ZWT	Zaślepka do wkrętów - typ TORX	36,00
ZWO	Zaślepka do łączników ościeżnic	52,00
ZWW	Zaślepka do wkrętów ościeżnicowych - typ WHO	52,00
KAP	Kapturek maskujący RAL	140,00

## Kotwa metalowa do mocowania drewnianej stolarki okiennej i drzwiowej

Mounting anchor for windows

INDEX	ZASTOSOWANIE APPLICATION	CENA / PRICE 1 szt./pcs [ PLN ]	INDEX	ZASTOSOWANIE APPLICATION	CENA / PRICE 1 szt./pcs [ PLN ]
KM1	Ościeżnice drzwiowe / Door frames	0,95	KM4	Okna PVC / PVC windows	0,95
KM2	Okna drewniane / Wooden windows	0,95	KM1P	Okna PVC / PVC windows	0,95
KM3	Urzędowski, Sokółka, Wołomin, Włoszczowa	0,95	KM1H	Okna drewniane / Wooden windows	0,95

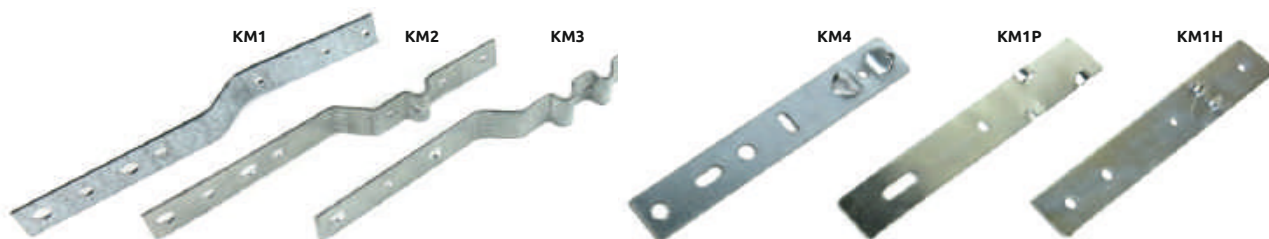

## Wkręt montażowy do cienkich blach, tworzyw sztucznych i drewna z tłem podkładowym \*

Wafer head phillips, sharp point screw hardened, zinc plated

ITB-KOT-2019/0761 wyd. 1



INDEX	ROZMIAR SIZE [mm]	ILOŚĆ [szt.] QUANTITY [pcs]		CENA / PRICE	
				1kg [PLN]	1000 szt./pcs [PLN]
WM-4213	4,2 x 13	250	6000	16,50	35,43
WM-4216	4,2 x 16	250	6000	16,50	38,46
WM-4219	4,2 x 19	250	6000	16,50	41,48
WM-4225	4,2 x 25	250	6000	16,50	48,51
WM-4230	4,2 x 30	250	6000	16,50	53,31
WM-4238	4,2 x 38	250	6000	16,50	62,00
WM-4250	4,2 x 50	250	3000	16,50	79,55
WM-4265	4,2 x 65	250	3000	16,50	103,00

## Wkręt montażowy do cienkich blach, tworzyw sztucznych i drewna z tłem podkładowym - fosfatowany \*

Wafer head phillips, sharp point screw hardened, phosphated

ITB-KOT-2019/0761 wyd. 1



INDEX	ROZMIAR SIZE [mm]	ILOŚĆ [szt.] QUANTITY [pcs]		CENA / PRICE	
				1kg [PLN]	1000 szt./pcs [PLN]
WMF-4213	4,2 x 13	250	6000	16,50	40,26
WMF-4216	4,2 x 16	250	6000	16,50	43,71
WMF-4219	4,2 x 19	250	6000	16,50	47,12
WMF-4225	4,2 x 25	250	6000	16,50	55,12
WMF-4230	4,2 x 30	250	6000	16,50	60,58
WMF-4238	4,2 x 38	250	6000	16,50	70,48
WMF-4250	4,2 x 50	250	3000	16,50	90,40
WMF-4265	4,2 x 65	250	3000	16,50	117,05

## Wkręt montażowy samowiertny uniwersalny, przewiercalność max. 2,25 mm \*

Wafer head phillips, self-drilling screw hardened, zinc plated

ITB-KOT-2019/0761 wyd. 1



INDEX	ROZMIAR SIZE [mm]	ILOŚĆ [szt.] QUANTITY [pcs]		CENA / PRICE	
				1kg [PLN]	1000 szt./pcs [PLN]
WMS-4213	4,2 x 13	250	6000	16,50	38,22
WMS-4216	4,2 x 16	250	6000	16,50	41,23
WMS-4219	4,2 x 19	250	6000	16,50	44,03
WMS-4225	4,2 x 25	250	6000	16,50	49,57
WMS-4232	4,2 x 32	250	6000	16,50	57,78
WMS-4240	4,2 x 40	250	6000	16,50	75,00
WMS-4250	4,2 x 50	250	3000	16,50	88,00
WMS-4265	4,2 x 65	250	3000	16,50	132,00

## Wkręt montażowy samowiertny uniwersalny fosfatowany, przewier. max. 2,25 mm \*

Wafer head phillips, self-drilling screw hardened, phosphated

ITB-KOT-2019/0761 wyd. 1



INDEX	ROZMIAR SIZE [mm]	ILOŚĆ [szt.] QUANTITY [pcs]		CENA / PRICE	
				1kg [PLN]	1000 szt./pcs [PLN]
WMSF-4213	4,2 x 13	250	6000	16,50	43,42
WMSF-4216	4,2 x 16	250	6000	16,50	46,85
WMSF-4219	4,2 x 19	250	6000	16,50	50,05
WMSF-4225	4,2 x 25	250	6000	16,50	56,32
WMSF-4232	4,2 x 32	250	6000	16,50	65,66
WMSF-4240	4,2 x 40	250	6000	16,50	82,15
WMSF-4250	4,2 x 50	250	3000	16,50	100,00
WMSF-4265	4,2 x 65	250	3000	16,50	150,00

\* - możliwość lakierowania w dowolnym kolorze według palety RAL  
- koszt lakierowania 30 PLN / 1000 sztuk

## Łącznik rozporowy pierścieniowy do betonu

Wedge anchor

AT-15-8312/2016

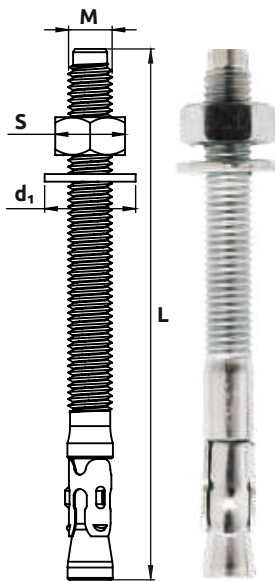

INDEX	ROZMIAR / SIZE [mm]				ILOŚĆ [szt.] QUANTITY [pcs]		CENA / PRICE 1000 szt./pcs [PLN]
	M	L	d <sub>1</sub>	S			
ŁP-06040	M6	40	12	10	200	2000	0,54
ŁP-06050	M6	50	12	10	200	2000	0,63
ŁP-06065	M6	65	12	10	150	1500	0,74
ŁP-06080	M6	80	12	10	140	1400	0,87
ŁP-06100	M6	100	12	10	100	1000	1,00
ŁP-06120	M6	120	12	10	100	1000	1,15
ŁP-08050	M8	50	16	13	100	1000	0,75
ŁP-08065	M8	65	16	13	90	900	0,81
ŁP-08075	M8	75	16	13	80	800	0,90
ŁP-08085	M8	85	16	13	70	700	1,00
ŁP-08095	M8	95	16	13	70	700	1,08
ŁP-08115	M8	115	16	13	50	500	1,31
ŁP-08130	M8	130	16	13	40	400	1,39
ŁP-08140	M8	140	16	13	40	400	1,48
ŁP-08150	M8	150	16	13	40	400	1,58
ŁP-10065	M10	65	20	17	50	500	1,13
ŁP-10080	M10	80	20	17	40	400	1,34
ŁP-10090	M10	90	20	17	35	350	1,40
ŁP-10105	M10	105	20	17	35	350	1,53
ŁP-10120	M10	120	20	17	30	300	1,73
ŁP-10140	M10	140	20	17	30	300	1,99
ŁP-10150	M10	150	20	17	30	300	2,04
ŁP-12070	M12	70	24	19	35	350	1,42
ŁP-12080	M12	80	24	19	30	300	1,60
ŁP-12090	M12	90	24	19	30	300	1,82
ŁP-12100	M12	100	24	19	25	250	1,97
ŁP-12110	M12	110	24	19	25	250	2,02
ŁP-12120	M12	120	24	19	25	250	2,15
ŁP-12130	M12	130	24	19	20	200	2,32
ŁP-12140	M12	140	24	19	20	200	2,51
ŁP-12160	M12	160	24	19	50	200	2,81
ŁP-12180	M12	180	24	19	45	180	3,31
ŁP-12200	M12	200	24	19	35	140	3,59
ŁP-12220	M12	220	24	19	30	120	3,91
ŁP-12240	M12	240	24	19	25	100	4,23
ŁP-16090	M16	90	30	24	25	200	3,23
ŁP-16100	M16	105	30	24	20	160	3,90
ŁP-16125	M16	125	30	24	20	160	4,20
ŁP-16145	M16	145	30	24	15	120	4,73
ŁP-16160	M16	160	30	24	30	120	5,15
ŁP-16180	M16	180	30	24	25	100	5,84
ŁP-16200	M16	200	30	24	25	100	6,18
ŁP-16220	M16	220	30	24	20	80	6,71
ŁP-16240	M16	240	30	24	20	80	7,26
ŁP-16250	M16	250	30	24	20	80	7,53
ŁP-20100	M20	100	37	30	12	96	5,61
ŁP-20120	M20	120	37	30	12	96	6,43
ŁP-20130	M20	130	37	30	10	80	7,00
ŁP-20160	M20	160	37	30	20	80	8,17
ŁP-20200	M20	200	37	30	15	60	9,90
ŁP-20220	M20	220	37	30	15	60	10,32
ŁP-24180	M24	180	44	36	10	40	17,80

## Kotwa opaskowa sufitowa z oczkiem

Ceiling anchor with eye yellow zinc

AT-15-8312/2016



INDEX	ROZMIAR SIZE [mm]	ILOŚĆ [szt.] QUANTITY [pcs]	CENA / PRICE 1000 szt./pcs [PLN]
SRS-06065	M6 x 65	500	470,00

### Kotwa śrubowa Anchor Bolt do betonu z łbem sześciokątnym z podkładką

Anchor Bolt

Produkt dostępny w 2021 r.  
Product available in 2021

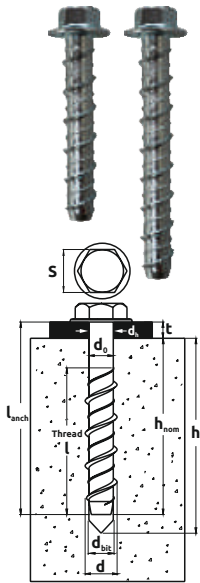

INDEX	ROZMIAR / SIZE [mm]											Nośność charakterystyczna ścinanie kN		ILOŚĆ [szt.] QUANTITY [pcs]	CENA / PRICE 1000 szt./pcs [PLN]		
	d <sub>bit</sub>	d	L <sub>sch</sub>	Thread	l	S	d <sub>o</sub>	h <sub>o</sub>	h <sub>nom</sub>	t	d <sub>h</sub>	d	h				
FCB-06/08030	6,5	8	30	25	10	6	35	25	5	8	25	50	20	2,38	9,53	100	955,95
FCB-06/08050	6,5	9	50	45	10	6	45	35	15	8	35	70	20	6,10	9,53	100	1 132,56
FCB-06/08075	6,5	8	75	70	10	6	45	35	40	8	35	70	20	6,10	9,53	50	1 518,84
FCB-08/10060	8	10	60	55	13	8	60	50	10	10	50	100	45	7,24	19,05	50	2 148,13
FCB-08/10075	8	10	75	70	13	8	60	50	25	10	50	100	45	7,24	19,05	50	2 499,09
FCB-08/10100	8	10	100	80	13	8	60	50	50	10	50	100	45	7,24	19,05	50	3 188,85
FCB-10/12060	10	12	60	55	17	10	60	50	10	12	50	100	60	8,48	30,48	50	3 336,64
FCB-10/12075	10	12	75	70	17	10	70	60	15	12	60	120	60	10,67	30,48	50	3 840,75
FCB-10/12100	10	12	100	95	17	10	70	60	40	12	60	120	60	10,67	30,48	25	4 546,62
FCB-10/12125	10	12	125	100	17	10	70	60	65	12	60	120	60	10,67	30,48	20	5 159,81
FCB-10/12150	10	12	150	100	17	10	70	60	90	12	60	120	60	10,67	30,48	50	6 162,95
FCB-12/14075	12	14	75	65	19	12	75	60	15	15	60	120	100	14,29	45,73	50	6 101,63
FCB-12/14100	12	14	100	90	19	12	85	70	30	15	70	140	100	18,58	45,73	25	7 261,03
FCB-12/14130	12	14	130	120	19	12	85	70	60	15	70	140	100	18,58	45,73	20	8 409,98
FCB-12/14150	12	14	150	120	19	12	85	70	80	15	70	140	100	18,58	45,73	20	9 444,49
FCB-12/14190	12	14	190	120	19	12	85	70	120	15	70	140	100	18,58	45,73	10	12 545,74
FCB-16/18130	16	18	130	120	24	16	120	100	30	19	100	200	200	30,48	80,02	10	17 769,42
FCB-16/18150	16	18	150	140	24	16	120	100	50	19	100	200	200	30,48	80,02	10	20 015,60

### Kotwa rozprężna do średnich obciążeń z nakrętką i podkładką / z hakiem sufitowym

Sleeve anchors / Sleeve anchors with ceiling hook

AT-15-8309/2016

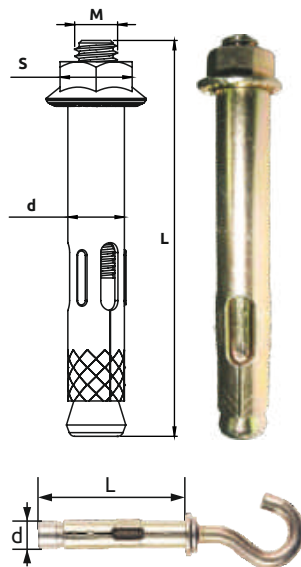

INDEX	ROZMIAR / SIZE [mm]				ILOŚĆ [szt.] QUANTITY [pcs]		CENA / PRICE 1000 szt./pcs [PLN]
	d	L	M	S	1000 szt./pcs	1 szt./pcs	
KT-08045	8	45	M6	10	100	1000	478,00
KT-08065	8	65	M6	10	50	500	635,00
KT-08085	8	85	M6	10	50	500	765,00
KT-10040	10	40	M8	13	50	500	805,00
KT-10050	10	50	M8	13	50	500	840,00
KT-10060	10	60	M8	13	50	500	900,00
KT-10080	10	80	M8	13	50	500	1 020,00
KT-10100	10	100	M8	13	50	500	1 320,00
KT-10120	10	120	M8	13	50	500	1 450,00
KT-12060	12	60	M10	17	50	250	1 340,00
KT-12075	12	75	M10	17	50	250	1 500,00
KT-12100	12	100	M10	17	50	250	1 920,00
KT-12130	12	130	M10	17	25	125	2 460,00
KT-16110	16	110	M12	19	10	100	2 640,00
KT-16150	16	150	M12	19	10	100	3 600,00
KT-20110	20	110	M16	24	5	50	6 000,00
KT-20150	20	150	M16	24	5	50	6 840,00
KTS-08040	8	40	-	-	50	1000	1 110,00
KTS-08060	8	60	-	-	50	1000	1 480,00

### Stalowy łącznik jednorozporowy SŁR-1

Steel single-expansion anchor bolt

AT-15-8253/2016

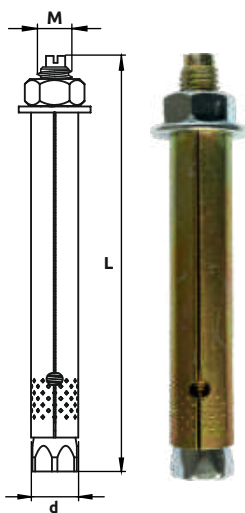

INDEX	ROZMIAR / SIZE [mm]		ŚR. ZEWNĘTRZNA OUTER DIAMETER [mm] d	ILOŚĆ [szt.] QUANTITY [pcs]	CENA / PRICE 1 szt./pcs [PLN]
	L	M			
J-06060	60	M6	10	100	2,25
J-06065	65	M6	10	100	2,37
J-06080	80	M6	10	100	2,67
J-06100	100	M6	10	100	2,91
J-06120	120	M6	10	100	3,15
J-06150	150	M6	10	100	3,38
J-08050	50	M8	12	100	2,72
J-08060	60	M8	12	100	2,75
J-08065	65	M8	12	100	2,79
J-08080	80	M8	12	100	2,84
J-08100	100	M8	12	100	3,03
J-08120	120	M8	12	100	3,17
J-08150	150	M8	12	50	3,50
J-08180	180	M8	12	50	3,98
J-08210	210	M8	12	50	4,36
J-08250	250	M8	12	100	5,02
J-10060	60	M10	14	100	3,43
J-10065	65	M10	14	100	3,48
J-10080	80	M10	16	50	3,57

**Stalowy łącznik jednorozporowy SŁR-1**  
 Steel single-expansion anchor bolt

AT-15-8253/2016

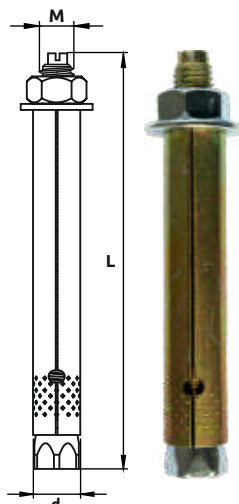

INDEX	ROZMIAR / SIZE [mm]		ŚR. ZEWNĘTRZNA OUTER DIAMETER [mm] d	ILOŚĆ [szt.] QUANTITY [pcs]	CENA / PRICE 1 szt./pcs [PLN]
	M	L			
J-10100	M10	100	16	50	4,59
J-10120	M10	120	16	50	4,69
J-10150	M10	150	16	50	4,88
J-10180	M10	180	16	25	5,66
J-10210	M10	210	16	25	6,44
J-10250	M10	250	16	25	7,22
J-10300	M10	300	16	25	8,80
J-12080	M12	80	18	50	4,85
J-12100	M12	100	18	50	5,11
J-12120	M12	120	18	50	5,51
J-12140	M12	140	18	50	5,94
J-12160	M12	160	18	25	6,67
J-12200	M12	200	18	25	7,83
J-12250	M12	250	18	25	8,12
J-12300	M12	300	18	25	10,13
J-16120	M16	120	25	25	12,49
J-16140	M16	140	25	25	13,21
J-16150	M16	150	25	25	13,36
J-16170	M16	170	25	25	14,03
J-16200	M16	200	25	25	14,92
J-16250	M16	250	25	25	16,87
J-16300	M16	300	25	25	18,62
J-20120	M20	120	27	15	18,74
J-20140	M20	140	27	15	21,05

**Stalowy łącznik dwurozporowy SŁR-2**  
 Steel double-expansion anchor bolt

AT-15-8253/2016

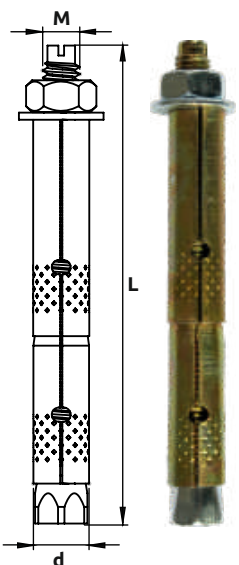

INDEX	ROZMIAR SIZE [mm]		ŚR. ZEWN. OUTER DIAMETER [mm] d	CENA / PRICE 1 szt./pcs [PLN]	INDEX	ROZMIAR SIZE [mm]		ŚR. ZEWN. OUTER DIAMETER [mm] d	CENA / PRICE 1 szt./pcs [PLN]
	M	L				M	L		
D-06100	M6	100	10	3,20	D-12210	M12	210	18	9,04
D-06150	M6	150	10	3,81	D-12250	M12	250	18	10,08
D-08100	M8	100	12	3,57	D-12260	M12	260	18	10,46
D-08120	M8	120	12	3,93	D-12300	M12	300	18	11,46
D-08150	M8	150	12	4,19	D-12350	M12	350	18	12,73
D-08180	M8	180	12	4,52	D-12400	M12	400	18	14,22
D-08210	M8	210	12	5,04	D-16160	M16	160	25	15,13
D-08250	M8	250	12	5,56	D-16180	M16	180	25	15,77
D-08280	M8	280	12	5,75	D-16200	M16	200	25	16,51
D-08300	M8	300	12	6,11	D-16250	M16	250	25	18,59
D-08350	M8	350	12	6,70	D-16300	M16	300	25	21,85
D-08400	M8	400	12	8,09	D-16350	M16	350	25	25,23
D-10100	M10	100	14	4,40	D-16400	M16	400	25	28,51
D-10101	M10	100	16	5,30	D-16450	M16	450	25	32,77
D-10120	M10	120	14	5,02	D-20160	M20	160	27	21,23
D-10121	M10	120	16	5,96	D-20180	M20	180	27	22,59
D-10150	M10	150	14	5,49	D-20200	M20	200	27	24,05
D-10151	M10	150	16	6,32	D-20220	M20	220	27	26,28
D-10180	M10	180	14	6,30	D-20250	M20	250	27	27,95
D-10181	M10	180	16	7,60	D-20260	M20	260	27	28,85
D-10210	M10	210	14	7,15	D-20280	M20	280	27	32,15
D-10211	M10	210	16	8,28	D-20300	M20	300	27	33,13
D-10230	M10	230	14	7,93	D-20350	M20	350	27	37,67
D-10250	M10	250	14	8,14	D-20400	M20	400	27	41,28
D-10251	M10	250	16	8,71	D-20500	M20	500	27	49,00
D-10280	M10	280	14	9,28	D-24160	M24	160	32	38,49
D-10300	M10	300	14	8,80	D-24200	M24	200	32	39,41
D-10301	M10	300	16	11,34	D-24250	M24	250	32	49,13
D-10350	M10	350	14	9,70	D-24300	M24	300	32	59,64
D-12100	M12	100	18	5,82	D-24320	M24	320	32	62,97
D-12120	M12	120	18	6,20	D-24350	M24	350	32	67,51
D-12140	M12	140	18	6,63	D-24400	M24	400	32	73,62
D-12160	M12	160	18	7,36	D-24450	M24	450	32	78,54
D-12180	M12	180	18	8,05	D-24500	M24	500	32	84,03
D-12200	M12	200	18	8,73					

### Stalowy łącznik SŁR z hakiem otwartym

Steel anchor bolt with ceiling hook

AT-15-8253/2016

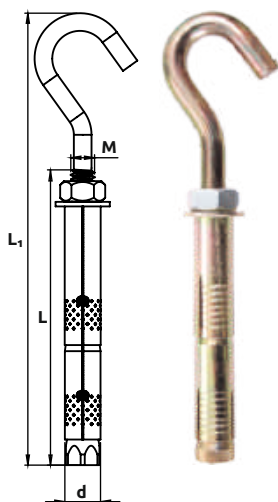

INDEX	ROZMIAR / SIZE [mm]			ŚR. ZEWNĘTRZNA OUTER DIAMETER [mm] d	CENA / PRICE 1 szt./pcs [PLN]
	M	L	L <sub>1</sub>		
HO-06065	M6	65	105	10	3,23
HO-06080	M6	80	120	10	3,54
HO-08080	M8	80	130	12	4,31
HO-08100	M8	100	150	12	5,10
HO-08120	M8	120	170	12	5,49
HO-08150	M8	150	200	12	5,77
HO-08180	M8	180	230	12	6,13
HO-08210	M8	210	260	12	6,87
HO-10100	M10	100	160	14	6,44
HO-10120	M10	120	180	14	7,13
HO-10150	M10	150	210	14	7,62
HO-10180	M10	180	240	14	8,62
HO-10210	M10	210	270	14	9,74
HO-12100	M12	100	170	18	8,77
HO-12120	M12	120	190	18	9,23
HO-12140	M12	140	210	18	9,69
HO-12160	M12	160	230	18	10,51
HO-12180	M12	180	250	18	11,23
HO-16160	M16	160	265	25	20,64
HO-16180	M16	180	285	25	21,28
HO-16200	M16	200	305	25	22,05

### Stalowy łącznik SŁR z hakiem zamkniętym

Steel anchor bolt with a closed hook

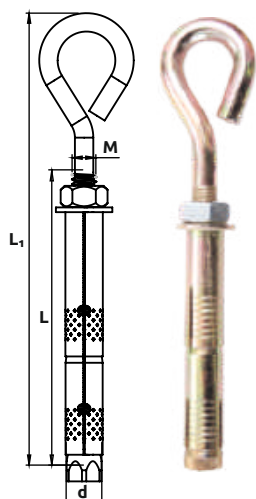

INDEX	ROZMIAR / SIZE [mm]			ŚR. ZEWNĘTRZNA OUTER DIAMETER [mm] d	CENA / PRICE 1 szt./pcs [PLN]
	M	L	L <sub>1</sub>		
HZ-06080	M6	80	120	10	3,54
HZ-06100	M6	100	140	10	3,87
HZ-08080	M8	80	130	12	4,01
HZ-08100	M8	100	150	12	4,31
HZ-08120	M8	120	170	12	5,10
HZ-08150	M8	150	190	12	5,49
HZ-08180	M8	180	230	12	5,77
HZ-08210	M8	210	260	12	6,13
HZ-10080	M10	80	140	14	6,87
HZ-10100	M10	100	160	14	6,44
HZ-10120	M10	120	180	14	7,13
HZ-10150	M10	150	210	14	7,62
HZ-10180	M10	180	240	14	8,62
HZ-10210	M10	210	270	14	9,74
HZ-12100	M12	100	170	18	8,77
HZ-12120	M12	120	190	18	9,23
HZ-12140	M12	140	210	18	9,69
HZ-12160	M12	160	230	18	10,51

### Stalowy łącznik SŁR z hakiem prostym

Steel anchor bolt with hook

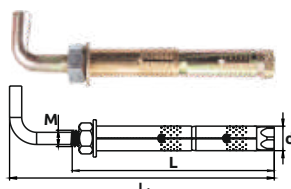

INDEX	ROZMIAR / SIZE [mm]			ŚR. ZEWNĘTRZNA OUTER DIAMETER [mm] d	CENA / PRICE 1 szt./pcs [PLN]
	M	L	L <sub>1</sub>		
HP-06065	M6	65	85	10	2,87
HP-08065	M8	65	90	12	3,54
HP-08080	M8	80	105	12	3,77
HP-10100	M10	100	135	14	5,72

### Stalowy łącznik SŁR z hakiem huśtawkowym

Steel anchor bolt with swing hook

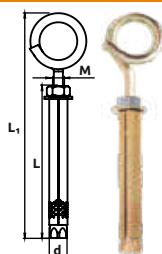

INDEX	ROZMIAR / SIZE [mm]			ŚR. ZEWNĘTRZNA OUTER DIAMETER [mm] d	CENA / PRICE 1 szt./pcs [PLN]
	M	L	L <sub>1</sub>		
HH-06065	M6	65	105	10	3,77
HH-06080	M6	80	120	10	3,90
HH-06100	M6	100	140	10	4,92
HH-08080	M8	80	130	12	5,57
HH-08100	M8	100	150	12	6,18
HH-10120	M10	120	180	14	8,69

Tuleja mosiężna  
Brass anchor

AT-15-8302/2016

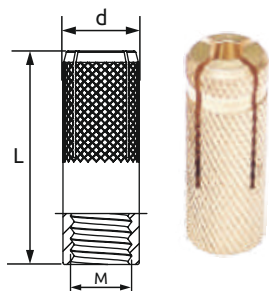

INDEX	ROZMIAR / SIZE [mm]			ILOŚĆ [szt.] QUANTITY [pcs]		CENA / PRICE 1000 szt./pcs [PLN]
	d	L	M			
TM-04	5	16	M4	100	6500	360,00
TM-05	7	20	M5	100	3200	390,00
TM-06	8	23	M6	100	3900	440,00
TM-08	10	28	M8	50	1950	660,00
TM-10	12	32	M10	50	1400	1090,00
TM-12	15	38	M12	25	700	2290,00
TM-14	18	42	M14	25	500	3860,00
TM-16	20	45	M16	25	350	4900,00

Tuleja stalowa  
Drop in anchor

AT-15-8302/2016

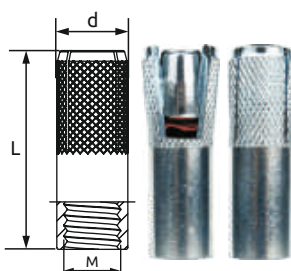

INDEX	ROZMIAR / SIZE [mm]			ILOŚĆ [szt.] QUANTITY [pcs]		CENA / PRICE 1000 szt./pcs [PLN]
	d	L	M			
TS-06	8	25	M6	100	4000	320,00
TS-08	10	30	M8	100	2000	410,00
TS-10	12	40	M10	50	1000	530,00
TS-12	16	50	M12	50	500	1 050,00
TS-14	18	55	M14	35	350	1 950,00
TS-16	20	65	M16	25	250	2 300,00
TS-20	25	80	M20	25	100	5 900,00

Osadzak do tulei stalowych  
Setting tool for steel drop in anchors

INDEX	ROZMIAR / SIZE [mm]		ILOŚĆ [szt.] QUANTITY [pcs]	CENA / PRICE 1 szt./pcs [PLN]
	m	L		
OTS-06	4,90	100	1	2,08
OTS-08	6,25	100	1	2,25
OTS-10	7,90	130	1	3,70
OTS-12	10,2	140	1	6,50
OTS-16	13,45	190	1	10,00

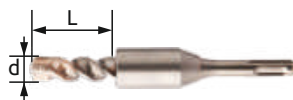
Wiertło do tulei stalowych  
Drilling tool for steel drop in anchors

INDEX	ROZMIAR / SIZE [mm]		ILOŚĆ [szt.] QUANTITY [pcs]	CENA / PRICE 1 szt./pcs [PLN]
	d	L		
N-SDS08-O	8	27	1	53,48
N-SDS10-O	10	32	1	54,42
N-SDS12-O	12	42	1	77,07

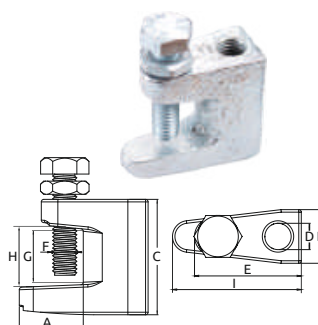
Zacisk TKL  
Beam clamp

INDEX	ROZMIAR / SIZE [mm]									CENA / PRICE 1 szt./pcs [PLN]
	A	B	C	D	E	F	G	H	I	
TKL08-M08	21	19	35	M8	35	M8	17	18,5	38	6,90
TKL08-D09	21	19	35	ø9 bez gwintu	35	M8	17	18,0	38	6,90
TKL10-M08	29	21	45	M8	41	M10	20	24,5	50	6,90
TKL10-M10	29	21	45	M10	41	M10	20	24,5	50	6,90
TKL10-D11	29	21	45	ø11 bez gwintu	41	M10	18	23,0	50	6,90
TKL12-M12	26	29,5	58	M12	55	M12	25	30,0	58	12,30
TKL12-M16	26	29,5	58	M16	55	M12	25	30,5	58	24,00

### Łącznik śrubowy odgięty - TYP L - czarny

T-rod l-type

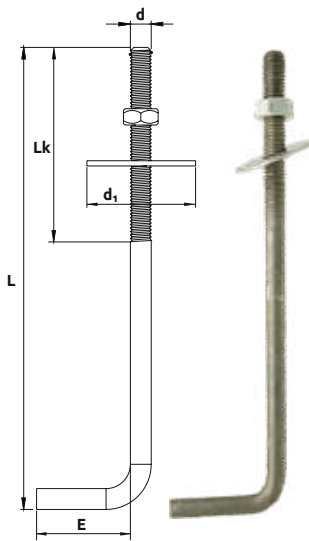

INDEX	ROZMIAR / SIZE [mm]					ILOŚĆ [szt.] QUANTITY [pcs]	CENA / PRICE 1 szt./pcs [PLN]
	d	L	Lk	E	d <sub>1</sub>		
KML-12250	M12	250	80	50	45	20	3,08
KML-12300	M12	300	80	50	45	20	3,36
KML-12350	M12	350	80	50	45	20	3,72
KML-12400	M12	400	80	50	45	20	4,08
KML-12450	M12	450	80	50	45	20	4,49
KML-12500	M12	500	80	50	45	20	4,79
KML-14250	M14	250	80	50	45	20	4,21
KML-14300	M14	300	80	50	45	20	4,62
KML-14350	M14	350	80	50	45	20	5,05
KML-14400	M14	400	80	50	45	20	5,38
KML-14450	M14	450	80	50	45	20	5,72
KML-14500	M14	500	80	50	45	20	6,18
KML-16300	M16	300	80	50	45	20	6,08
KML-16350	M16	350	80	50	45	20	6,51
KML-16400	M16	400	80	50	45	20	7,08
KML-16450	M16	450	80	50	45	20	7,54
KML-16500	M16	500	80	50	45	20	8,10

### Łącznik śrubowy odgięty - TYP L - ocynkowany

T-rod l-type

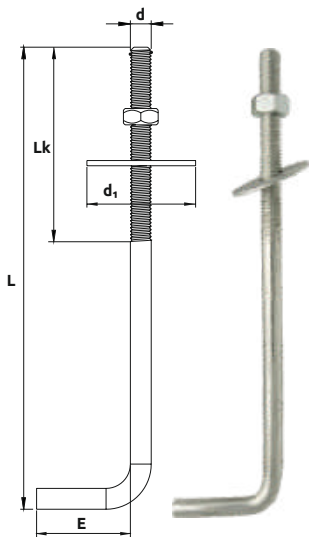

INDEX	ROZMIAR / SIZE [mm]					ILOŚĆ [szt.] QUANTITY [pcs]	CENA / PRICE 1 szt./pcs [PLN]
	d	L	Lk	E	d <sub>1</sub>		
KMLO-12250	M12	250	80	50	45	20	3,36
KMLO-12300	M12	300	80	50	45	20	3,82
KMLO-12350	M12	350	80	50	45	20	4,21
KMLO-12400	M12	400	80	50	45	20	4,59
KMLO-12450	M12	450	80	50	45	20	4,95
KMLO-12500	M12	500	80	50	45	20	5,41
KMLO-14250	M14	250	80	50	45	20	4,62
KMLO-14300	M14	300	80	50	45	20	5,23
KMLO-14350	M14	350	80	50	45	20	5,82
KMLO-14400	M14	400	80	50	45	20	6,36
KMLO-14450	M14	450	80	50	45	20	6,87
KMLO-14500	M14	500	80	50	45	20	7,46
KMLO-16300	M16	300	80	50	45	20	7,08
KMLO-16350	M16	350	80	50	45	20	7,79
KMLO-16400	M16	400	80	50	45	20	8,54
KMLO-16450	M16	450	80	50	45	20	9,33
KMLO-16500	M16	500	80	50	45	20	10,10

### Hak huśtawkowy

Hook pigtail

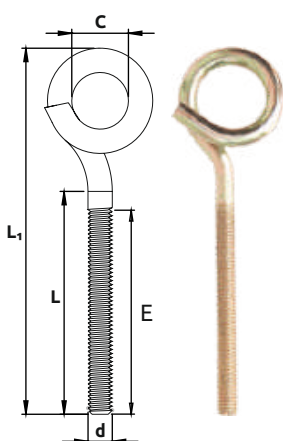

INDEX	ROZMIAR SIZE [mm]					ILOŚĆ [szt.] QUANTITY [pcs]	CENA / PRICE 1 szt./pcs [PLN]
	d	L	L <sub>1</sub>	E	C		
HHH-06050	M6	50	84	40	17,2	50	0,95
HHH-06065	M6	65	100	55	17,2	50	1,05
HHH-06080	M6	80	115	70	17,2	25	1,23
HHH-06100	M6	100	135	90	17,2	25	1,52
HHH-06150	M6	150	185	140	17,2	10	1,60
HHH-08080	M8	80	134	70	32,0	25	1,83
HHH-08100	M8	100	156	90	32,0	25	1,90
HHH-08120	M8	120	175	110	32,0	25	2,01
HHH-08160	M8	160	214	150	32,0	10	2,33
HHH-10100	M10	100	165	90	33,0	25	2,84
HHH-10120	M10	120	185	110	33,0	10	3,47
HHH-10200	M10	200	260	190	33,0	10	4,43
HHH-12200	M12	200	265	180	37,0	10	7,63

## Hak oczkowy zamknięty HHZ

Hook O-type

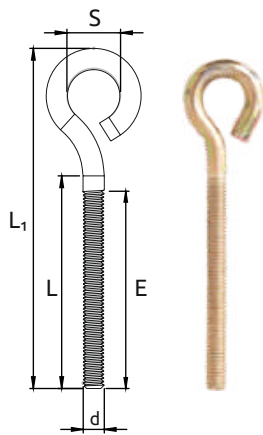

INDEX	ROZMIAR SIZE [mm]					ILOŚĆ [szt.] QUANTITY [pcs]	CENA / PRICE 1 szt./pcs [PLN]
	d	L	L <sub>1</sub>	E	S		
HHZ-06050	M6	50	77	40	13,6	50	0,58
HHZ-06060	M6	60	87	50	13,6	50	0,62
HHZ-06080	M6	80	107	70	13,6	25	0,65
HHZ-06100	M6	100	127	90	13,6	25	0,95
HHZ-06130	M6	130	157	120	13,6	10	1,00
HHZ-06150	M6	150	177	140	13,6	10	1,11
HHZ-08050	M8	50	84	40	15,8	50	0,90
HHZ-08060	M8	60	94	50	15,8	50	1,21
HHZ-08100	M8	100	134	90	15,8	25	1,37
HHZ-08150	M8	150	184	140	15,8	25	1,61
HHZ-08160	M8	160	194	150	15,8	10	1,75
HHZ-08180	M8	180	214	170	15,8	10	2,06
HHZ-10050	M10	50	93	40	19,7	50	1,65
HHZ-10060	M10	60	103	50	19,7	50	1,89
HHZ-10070	M10	70	113	60	19,7	25	2,06
HHZ-10080	M10	80	123	70	19,7	25	2,23
HHZ-10100	M10	100	143	90	19,7	25	2,42
HHZ-10120	M10	120	163	110	19,7	10	2,62
HHZ-10150	M10	150	193	140	19,7	10	2,75
HHZ-10180	M10	180	223	170	19,7	10	3,09
HHZ-10200	M10	200	243	190	19,7	10	3,13

## Hak zagięty otwarty HHO

Hook C-type

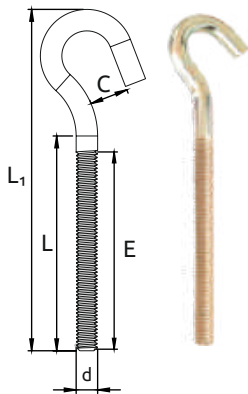

INDEX	ROZMIAR SIZE [mm]					ILOŚĆ [szt.] QUANTITY [pcs]	CENA / PRICE 1 szt./pcs [PLN]
	d	L	L <sub>1</sub>	E	C		
HHO-06050	M6	50	77	40	5,2	50	0,58
HHO-06060	M6	60	87	50	5,2	50	0,66
HHO-06080	M6	80	107	70	5,2	25	0,69
HHO-08050	M8	50	84	40	7,0	50	1,05
HHO-08060	M8	60	94	50	7,0	50	1,10
HHO-08100	M8	100	134	90	7,0	25	1,18
HHO-08160	M8	160	194	150	7,0	25	1,72
HHO-08180	M8	180	214	170	7,0	25	2,04
HHO-10120	M10	120	163	110	8,7	25	2,56
HHO-10180	M10	180	223	170	8,7	25	3,07

## Hak zagięty prosty HHP

Hook square

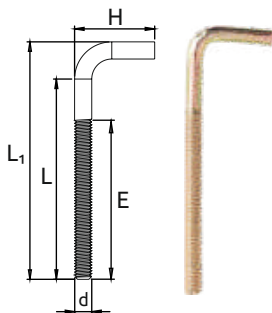

INDEX	ROZMIAR SIZE [mm]					ILOŚĆ [szt.] QUANTITY [pcs]	CENA / PRICE 1 szt./pcs [PLN]
	d	L	L <sub>1</sub>	E	H		
HHP-06070	M6	70	75	50	20	50	0,79
HHP-08070	M8	70	77	50	23	50	0,90
HHP-08080	M8	80	87	60	23	50	1,08
HHP-08160	M8	160	167	130	26	25	1,88
HHP-10100	M10	100	109	80	30	25	1,94
HHP-10160	M10	160	169	140	30	25	2,66
HHP-10180	M10	180	189	160	30	25	2,92

### Pręt gwintowany czarny i ocynkowany

Threaded rod



INDEX	ROZMIAR SIZE [mm] M x L	ILOŚĆ [szt.] QUANTITY [pcs]		WAGA / WEIGHT 100 szt./pcs [kg]	CENA / PRICE 1 szt./pcs [ PLN ]	
					CZARNA/BLACK	OCYNK/ZINC
PRI-03100	M3 x 1000	100	9000	4,0		0,96
PRI-04100	M4 x 1000	100	9000	7,0		1,11
PRI-05100	M5 x 1000	100	9000	11,0		1,30
PRI-06100	M6 x 1000	100	7900	15,1	1,27	1,33
PRI-08100	M8 x 1000	50	4600	26,0	1,98	2,08
PRI-10100	M10 x 1000	25	2900	41,5	3,15	3,25
PRI-12100	M12 x 1000	20	1900	61,7	4,56	4,70
PRI-14100	M14 x 1000	10	1300	89,0	6,51	6,87
PRI-16100	M16 x 1000	10	1000	120,0	8,88	9,25
PRI-18100	M18 x 1000	10	770	154,0	12,00	12,63
PRI-20100	M20 x 1000	5	610	194,0	14,26	15,01
PRI-22100	M22 x 1000	5	490	242,0		19,81
PRI-24100	M24 x 1000	5	420	280,0	20,92	21,93
PRI-27100	M27 x 1000	5	320	365,0		33,31
PRI-30100	M30 x 1000	1	260	456,0	39,41	41,48
PRI-33100	M33 x 1000	1	200	577,0		52,63
PRI-36100	M36 x 1000	1	170	677,0		61,70
PRI-42100	M42 x 1000	1	120	936,0		95,72
PRI-06200	M6 x 2000	50	3900	30,2		2,88
PRI-08200	M8 x 2000	25	2300	52,0		4,58
PRI-10200	M10 x 2000	25	1450	83,0		7,08
PRI-12200	M12 x 2000	10	980	123,4		10,22
PRI-14200	M14 x 2000	10	670	178,0		15,02
PRI-16200	M16 x 2000	10	500	240,		20,18
PRI-20200	M20 x 2000	5	300	388,0		32,85
PRI-24200	M24 x 2000	5	210	560,0		51,40
PRI-30200	M30 x 2000	5	130	874,0		88,93
PRI-06300	M6 x 3000	10	2600	45,3		5,52
PRI-08300	M8 x 3000	10	1500	78,0		8,60
PRI-10300	M10 x 3000	10	970	124,5		13,30
PRI-12300	M12 x 3000	10	650	185,1		19,15
PRI-16300	M16 x 3000	10	300	360,0		37,00

### Pręt gwintowany ocynkowany kl. 8.8

Threaded rod



INDEX	ROZMIAR SIZE [mm] M x L	ILOŚĆ [szt.] QUANTITY [pcs]		WAGA / WEIGHT 100 szt./pcs [kg]	CENA / PRICE 1 szt./pcs [ PLN ]
PRI-061008	M6 x 1000	100	6000	16,9	2,45
PRI-081008	M8 x 1000	50	3000	31,2	4,05
PRI-101008	M10 x 1000	25	2000	49,8	6,25
PRI-121008	M12 x 1000	20	1500	71,4	8,53
PRI-141008	M14 x 1000	10	1000	99,4	12,70
PRI-161008	M16 x 1000	10	750	131,2	16,17
PRI-181008	M18 x 1000	10	600	165,0	22,38
PRI-201008	M20 x 1000	5	500	205,3	28,20
PRI-221008	M22 x 1000	5	490	242,0	34,32
PRI-241008	M24 x 1000	5	300	296,0	41,15
PRI-271008	M27 x 1000	5	300	373,0	52,83
PRI-301008	M30 x 1000	1	200	469,0	65,82
PRI-331008	M33 x 1000	1	180	577,0	81,78
PRI-361008	M36 x 1000	1	150	677,0	96,58
PRI-421008	M42 x 1000	1	100	936,0	133,97
PRI-082008	M8 x 2000	25	1500	62,4	8,85
PRI-102008	M10 x 2000	25	1000	99,6	13,63
PRI-122008	M12 x 2000	10	750	142,8	18,23
PRI-162008	M16 x 2000	10	400	262,4	35,27
PRI-202008	M20 x 2000	5	250	410,6	56,42
PRI-222008	M22 x 2000	5	250	420,0	76,54
PRI-242008	M24 x 2000	5	150	592,0	82,30
PRI-302008	M30 x 2000	5	100	938,00	138,42

Pręt gwintowany ze stali nierdzewnej A2  
Threaded rod

INDEX	ROZMIAR SIZE [mm] M x L	ILOŚĆ [szt.] QUANTITY [pcs]		WAGA / WEIGHT 100 szt./pcs [kg]	CENA / PRICE 1 szt./pcs [PLN]
PRIA-05100	M5 x 1000	100	9000	12,3	6,90
PRIA-06100	M6 x 1000	100	6000	16,9	7,20
PRIA-08100	M8 x 1000	50	3000	31,2	12,00
PRIA-10100	M10 x 1000	50	3000	49,8	19,03
PRIA-12100	M12 x 1000	20	1500	71,4	27,66
PRIA-14100	M14 x 1000	10	1000	99,4	34,48
PRIA-16100	M16 x 1000	10	750	131,2	51,09
PRIA-20100	M20 x 1000	5	600	210,0	48,50
PRIA-30100	M30 x 1000	1	250	472,0	146,00

Nakrętka złączna ocynkowana  
Coupling nut

DIN 6334

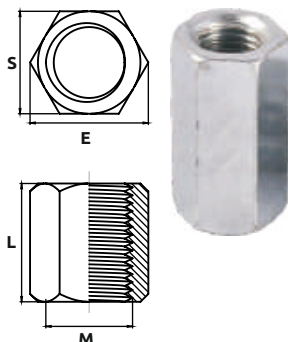

INDEX	ROZMIAR / SIZE [mm]				WAGA / WEIGHT 1000 szt./pcs [kg]	ILOŚĆ [szt.] QUANTITY [pcs]	CENA / PRICE 1 szt./pcs [PLN]
	M	L	S	E			
NZ-04	M4	12	7	7,80	6,0	300	0,28
NZ-05	M5	15	8	8,79	7,0	300	0,29
NZ-06	M6	18	10	11,05	8,1	250	0,44
NZ-08	M8	24	13	15,00	13,2	100	0,49
NZ-10	M10	30	17	19,60	22,7	50	0,85
NZ-12	M12	36	19	21,90	45,0	50	1,24
NZ-14	M14	42	22	24,50	88,0	25	1,29
NZ-16	M16	48	24	27,70	107,5	25	2,56
NZ-18	M18	54	27	31,20	140,0	25	3,60
NZ-20	M20	60	30	34,00	188,5	25	4,26
NZ-22	M22	66	32	35,70	260,0	25	4,90
NZ-24	M24	72	36	41,60	333,0	25	7,86
NZ-30	M30	90	46	50,85	500,0	25	23,96

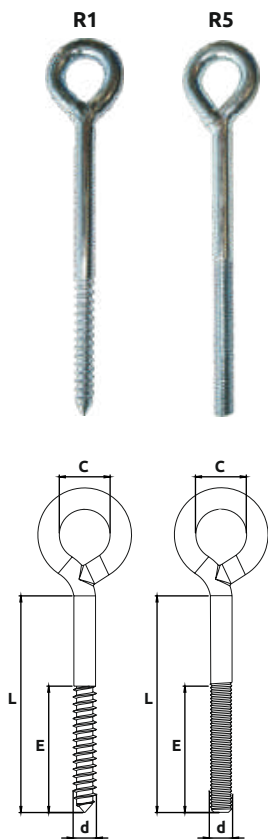
Hak do rusztowań - stal galwanicznie ocynkowana  
Eye bolt white zinc plated, welded, thread for wood/ metric

INDEX	ROZMIAR SIZE [mm]				ILOŚĆ [szt.] QUANTITY [pcs]	CENA / PRICE 1 szt./pcs [PLN]	
	d	L	E	C		DREWNO R1 WOOD R1	METRYCZNY R5 METRIC THREAD R5
HRR-08090	8	90	54	20	25	2,00	1,96
HRR-08100	8	100	54	20	25		2,00
HRR-08120	8	120	54	20	25	2,36	2,10
HRR-08150	8	150	54	20	25		2,20
HRR-08160	8	160	54	20	25	2,70	2,62
HRR-08180	8	180	54	20	25		2,70
HRR-08190	8	190	54	20	25	2,90	2,80
HRR-08200	8	200	54	20	25		3,00
HRR-08230	8	230	54	20	25		3,00
HRR-08260	8	260	54	20	25		3,10
HRR-10090	10	90	65	20	25	3,78	3,10
HRR-10120	10	120	65	20	25	4,14	3,50
HRR-10160	10	160	65	20	25	4,24	3,88
HRR-10190	10	190	65	20	25	4,60	4,50
HRR-10230	10	230	65	20	25	4,70	4,66
HRR-10260	10	260	65	20	25	4,90	4,85
HRR-10300	10	300	65	20	25	5,58	5,50
HRR-10350	10	350	65	20	25	5,94	5,60
HRR-12090	12	90	65	24	25	4,40	4,10
HRR-12120	12	120	65	24	25	4,96	4,50
HRR-12160	12	160	65	24	25	5,55	4,95
HRR-12190	12	190	65	24	25	6,21	5,14
HRR-12230	12	230	65	24	25	6,54	5,86
HRR-12250	12	250	65	24	25		6,10
HRR-12260	12	260	65	24	25	6,92	6,40
HRR-12300	12	300	65	24	25	7,35	6,80
HRR-12350	12	350	65	24	25	7,45	7,89
HRR-12400	12	400	65	24	25	9,25	
HRR-12450	12	450	65	24	25	9,64	
HRR-12500	12	500	65	24	25	10,34	

### Żywica chemiczna bezstyrenowa

Chemical anchors, styrene-free

ETA-11/0396  
ETA-15/0560

ETA-09/0140  
ETA-09/0246



INDEX	NAZWA NAME	POJEMNOŚĆ CAPACITY [ml]	ILOŚĆ [szt.] QUANTITY [pcs]	CENA / PRICE 1 szt./pcs [PLN]
KCH001	Poliestrowa żywica bezstyrenowa / Chemical Anchors Polyester	300	12	24,00
KCH002	Poliestrowa żywica bezstyrenowa / Chemical Anchors Polyester	400	12	35,60
KCH003	Epoksydowo-akrylowa żywica bezstyrenowa / Chemical Anchors Epoxy-acrylate	300	12	29,50
KCH004	Winyloestrowa żywica bezstyrenowa (zimowa) / WINTER Chemical Anchors Vinyl-ester	300	12	32,00



DO KOTWIENIA  
W NISKICH TEMPERATURACH  
NAWET DO -20°C

### Pręt gwintowany kl. 5.8 z zakończeniem heksagonalnym

Chemical Anchor Threaded Rod

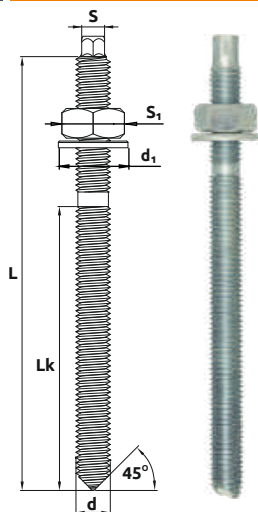

INDEX	ROZMIAR / SIZE [mm]						ILOŚĆ [szt.] QUANTITY [pcs]	CENA / PRICE 1 szt./pcs [PLN]
	d	L	Lk	S	S <sub>1</sub>	d <sub>1</sub>		
KCH08110	8	110	80	5	13	16	10	1,50
KCH08160	8	160	80	5	13	16	10	1,90
KCH10130	10	130	90	6	17	20	10	2,50
KCH10160	10	160	90	6	17	20	10	3,00
KCH12160	12	160	110	8	19	24	10	3,20
KCH12210	12	210	110	8	19	24	10	4,17
KCH16190	16	190	125	10	24	30	10	6,20
KCH16250	16	250	125	10	24	30	10	8,30
KCH20260	20	260	170	12	30	37	5	13,70

### Tuleja siatkowa

Plastic sleeve

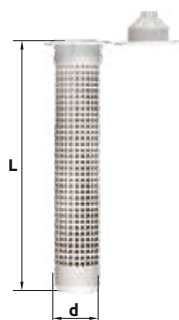

INDEX	ROZMIAR / SIZE [mm]		ILOŚĆ [szt.] QUANTITY [pcs]	CENA / PRICE 1 szt./pcs [PLN]
	d	L		
KCH-03	12	60	10	0,60
KCH-04	15	85	10	0,60
KCH-05	15	130	10	0,80
KCH-06	20	85	10	0,80

## Wyciskacz do kotew chemicznych

Caulking gun for chemical anchors

INDEX	NAZWA NAME	ILOŚĆ [szt.] QUANTITY [pcs]	CENA / PRICE 1 szt./pcs [PLN]
N-W03-1	Wyciskacz do mas chemicznych 15" K2 INDUSTRY (zamknięty)	1	68,25
N-W05	Wyciskacz do kotew chemicznych 300ml K2 PRO (siła nacisku >3000N; przełożenie 25:1)	1	49,68
N-W06	Wyciskacz do kotew chemicznych 380/410ml K2 INDUSTRY (siła nac. >5000N; przełożenie 25:1)	1	102,85

Akcesoria  
Accessories

INDEX	NAZWA NAME	ILOŚĆ [szt.] QUANTITY [pcs]	CENA / PRICE 1 szt./pcs [PLN]
KCH-13	Mikser mieszający do mas chemicznych / Mixing nozzle	5	1,60
KCH-14	Pompka do wydmuchiwania zwiercin / Blow out pump	1	45,00

Szczotka do czyszczenia otworów  
Hole cleaning brush

INDEX	NAZWA NAME	ILOŚĆ [szt.] QUANTITY [pcs]	CENA / PRICE 1 szt./pcs [PLN]
KCH-17	Szczotka do czyszczenia otworów $\varnothing$ 13-18mm	1	26,20
KCH-18	Szczotka do czyszczenia otworów $\varnothing$ 19-28mm	1	28,50

### Łącznik do izolacji z trzpieniem poliamidowym

Connector for insulation with polyamide stud



KRÓTKA STREFA ROZPOROWA

INDEX	DŁUGOŚĆ ŁĄCZNIKA LENGTH [mm]	MAKSYMALNA GRUBOŚĆ MATERIAŁU IZOLACYJNEGO INSULATION MATERIAL THICKNESS [mm]	ILOŚĆ [szt.] QUANTITY [pcs]	CENA / PRICE 1000 szt./pcs [PLN]
ŁIN-070	70	10-20	200	187,00
ŁIN-090	90	30-40	200	200,00
ŁIN-100	100	40-50	200	215,00
ŁIN-120	120	60-70	200	226,00
ŁIN-140	140	80-90	200	250,00
ŁIN-160	160	100-110	200	280,00
ŁIN-180	180	120-130	200	310,00
ŁIN-200	200	140-150	200	360,00
ŁIN-220	220	150-170	200	420,00
ŁIN-260	260	200-210	100	450,00

### Łącznik do izolacji z trzpieniem poliamidowym z przedłużoną strefą rozporową

Connector for insulation with polyamide stud with extended expansion zone



PRZEDŁUŻONA STREFA ROZPOROWA

INDEX	DŁUGOŚĆ ŁĄCZNIKA LENGTH [mm]	MAKSYMALNA GRUBOŚĆ MATERIAŁU IZOLACYJNEGO INSULATION MATERIAL THICKNESS [mm]	ILOŚĆ [szt.] QUANTITY [pcs]	CENA / PRICE 1000 szt./pcs [PLN]
ŁIPN-140	140	50-60	200	300,00
ŁIPN-160	160	70-80	200	320,00
ŁIPN-180	180	90-100	200	350,00
ŁIPN-200	200	110-120	200	395,00
ŁIPN-220	220	130-140	200	430,00
ŁIPN-260	260	170-180	100	500,00

### Łącznik do izolacji z trzpieniem metalowym z łbem z poliamidu

Connector for insulation with metal stud and polyamide head



KRÓTKA STREFA ROZPOROWA

INDEX	DŁUGOŚĆ ŁĄCZNIKA LENGTH [mm]	MAKSYMALNA GRUBOŚĆ MATERIAŁU IZOLACYJNEGO INSULATION MATERIAL THICKNESS [mm]	ILOŚĆ [szt.] QUANTITY [pcs]	CENA / PRICE 1000 szt./pcs [PLN]
ŁIMO-090	90	30-40	200	495,00
ŁIMO-120	120	60-70	200	540,00
ŁIMO-140	140	80-90	200	585,00
ŁIMO-160	160	100-110	200	650,00
ŁIMO-180	180	120-130	200	710,00
ŁIMO-200	200	140-150	200	890,00
ŁIMO-220	220	150-170	200	945,00
ŁIMO-260	260	200-210	100	1100,00
ŁIMO-300*	300	240-250	100	1920,00
ŁIMO-350*	350	290-300	100	3170,00
ŁIMO-400*	400	340-350	100	4310,00

\* Produkt dostępny w 2021 r. / Product available in 2021

### Łącznik do izolacji z trzpieniem metalowym z łbem z poliamidu z przedłużoną płaszczyzną podziału

Connector for insulation with metal stud with polyamide head and extended parting plane



PRZEDŁUŻONA STREFA ROZPOROWA

INDEX	DŁUGOŚĆ ŁĄCZNIKA LENGTH [mm]	MAKSYMALNA GRUBOŚĆ MATERIAŁU IZOLACYJNEGO INSULATION MATERIAL THICKNESS [mm]	ILOŚĆ [szt.] QUANTITY [pcs]	CENA / PRICE 1000 szt./pcs [PLN]
ŁIPMO-140	140	50-60	200	580,00
ŁIPMO-160	160	70-80	200	650,00
ŁIPMO-180	180	90-100	200	710,00
ŁIPMO-200	200	110-120	200	890,00
ŁIPMO-220	220	130-140	200	1000,00
ŁIPMO-260	260	170-180	100	1200,00
ŁIPMO-300*	300	210-220	100	1920,00
ŁIPMO-350*	350	260-270	100	3170,00
ŁIPMO-400*	400	310-320	100	4310,00

\* Produkt dostępny w 2021 r. / Product available in 2021

## Frez do wiercenia otworów

Cutter for holes

STYR-01



STYR-06



INDEX	ŚREDNICA DIAMETER [mm]	RODZAJ TYPE	ILOŚĆ [szt.] QUANTITY [pcs]	CENA / PRICE 1 szt./pcs [ PLN ]
STYR-01	67	styropian / styrofoam	1	11,00
STYR-011	65	wełna / mineral wool	1	160,00

## Zaślepka styropianowa / wełniana

Styrofoam / mineral wool plug

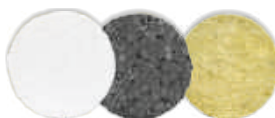

INDEX	ŚREDNICA DIAMETER [mm]	KOLOR COLOR	ILOŚĆ [szt.] QUANTITY [pcs]		CENA / PRICE 1000 szt./pcs [ PLN ]
STYR-02	67	biały / white	100	2000	110,00
STYR-03	67	grafit / graphite	100	2000	120,00
STYR-05	65	wełna / mineral wool	100	2000	600,00

## Kołnierz dociskowy z zaślepką

Pressure flange with a plug



INDEX	ŚREDNICA DIAMETER [mm]	MIN. ZAKOTWIENIE W DREWNIENIE MINIMAL ANCHORAGE IN WOOD [mm]	ROZMIAR SIZE [mm]	ILOŚĆ [szt.] QUANTITY [pcs]	CENA / PRICE 1000 szt./pcs [ PLN ]
ŁIK	60	20	4,8 - 6,0	500	186,00

\* PRODUKT NIE ZAWIERA WIDOCZNEGO NA ZDJĘCIU WKRETA  
\* THE PRODUCT DOES NOT CONTAIN THE SCREW SHOWN IN THE ILLUSTRATION

## Talerzyk dociskowy do mocowania wełny

Pressure plate for fastening wool



INDEX	ŚREDNICA DIAMETER [mm]	ILOŚĆ [szt.] QUANTITY [pcs]	CENA / PRICE 1000 szt./pcs [ PLN ]
KWL-140 polipropylen	140	300	450,00
KWL-140 poliamid	140	300	900,00

## Dybel do mocowania w fasadzie ocieplonej styropianem lub wełną (polipropylen/poliamid)

Pin for fastening in the insulation thermally insulated (polypropylene/polyamide)



INDEX	TWORZYWO MATERIAL	ROZMIAR / SIZE [mm]						ILOŚĆ [szt.] QUANTITY [pcs]		CENA / PRICE 1000 szt./pcs [ PLN ]
		d	L	T	Ø	D <sub>min</sub>	D <sub>max</sub>	50	90	
PFI-50	polipropylen polypropylene	25	50	T40	4,5 5,0	35+h <sub>ef</sub> 30+h <sub>ef</sub>	45+h <sub>ef</sub> 45+h <sub>ef</sub>	50	600	780,00
PFI-90	polipropylen polypropylene	25	90	T40	4,5 5,0	35+h <sub>ef</sub> 30+h <sub>ef</sub>	80+h <sub>ef</sub> 70+h <sub>ef</sub>	25	300	1250,00
PFI-50N	poliamid polyamide	25	50	T40	4,0 4,5	30+h <sub>ef</sub> 30+h <sub>ef</sub>	45+h <sub>ef</sub> 45+h <sub>ef</sub>	50	600	1000,00
PFI-90N	poliamid polyamide	25	90	T40	4,0 4,5	30+h <sub>ef</sub> 30+h <sub>ef</sub>	80+h <sub>ef</sub> 70+h <sub>ef</sub>	25	300	1600,00

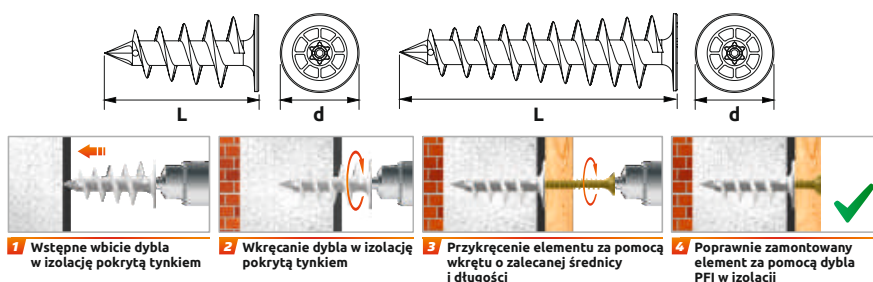
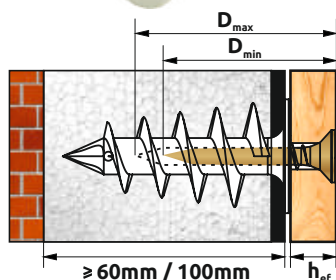

## Podkładka dystansowa pod zbrojenie (polipropylen)

Reinforcement spacers



INDEX	GRUBOŚĆ OTULINY BETONU THICKNESS OF THE CONCRETE COVER [mm]	ŚREDNICA PRĘTA DIAMETER OF THE ROD [mm]	ILOŚĆ [szt.] QUANTITY [pcs]		CENA / PRICE 1000 szt./pcs [ PLN ]
DYS	15/20/25/30	4-12	100	2000	130,00

### Tuleja 45 z polipropylenu do mocowania pokryć dachowych, okrągła

Telescopic sleeve with round plate



**UWAGA!**  
Długość robocza kołka teleskopowego jest o 15mm krótsza od długości całkowitej.

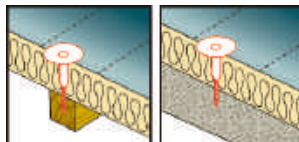

INDEX	DŁUGOŚĆ LENGTH [mm]	ILOŚĆ [szt.] QUANTITY [pcs]	CENA / PRICE 1000 szt./pcs [PLN]
GOK-035	35	500	379,00
GOK-045	45	500	389,00
GOK-055	55	500	405,00
GOK-065	65	500	417,20
GOK-085	85	500	432,90
GOK-105	105	500	478,10
GOK-135	135	500	545,90
GOK-155	155	500	575,23
GOK-165	165	500	599,20
GOK-185	185	500	685,70
GOK-225	225	500	892,00
GOK-235	235	500	1 065,60
GOK-255	255	500	1 112,00
GOK-285	285	500	1 166,30

### DOBÓR ŁĄCZNIKÓW / SELECTION OF THE CONNECTOR

PODŁOŻE STALOWE / STEEL SUBSTRATE GOK + EDSB			PODŁOŻE BETONOWE / CONCRETE SUBSTRATE GOK + EDSS + KKW08L60			PODŁOŻE BETONOWE / CONCRETE SUBSTRATE GOK + GTHD		
GR. IZOLACJI INSULATION THICKNESS [mm]	DŁ. TULEI PLUG LENGTH [mm]	DŁ. WKRETA SCREW LENGTH [mm]	GR. IZOLACJI INSULATION THICKNESS [mm]	DŁ. TULEI PLUG LENGTH [mm]	DŁ. WKRETA SCREW LENGTH [mm]	GR. IZOLACJI INSULATION THICKNESS [mm]	DŁ. TULEI PLUG LENGTH [mm]	DŁ. WKRETA SCREW LENGTH [mm]
30	15	50	30	15	90			
40	15	60	40	15	100			
50	35	50	50	35	90	50	35	60
60	35	60	60	35	100	60	35	70
70	35	70	70	35	110	70	35	80
80	65	50	80	65	90	80	65	60
90	65	60	90	65	100	90	65	70
100	85	50	100	85	90	100	85	60
110	85	60	110	85	100	110	85	70
120	105	50	120	105	90	120	105	60
130	105	60	130	105	100	130	105	70
140	105	70	140	105	110	140	105	80
150	135	50	150	135	90	150	135	60
160	135	60	160	135	100	160	135	70
170	135	70	170	135	110	170	165	80
180	165	50	180	165	90	180	165	60
190	165	60	190	165	100	190	165	70
200	185	50	200	185	90	200	185	60
210	185	60	210	185	100	210	185	70
220	185	70	220	185	110	220	185	80
230	185	80	230	185	120	230	185	90
240	185	90	240	185	130	240	185	100
250	225	60	250	225	100	250	235	60
260	225	70	260	225	110	260	235	70
270	225	80	270	225	120	270	235	80
280	255	60	280	255	100	280	235	90
300	255	80	300	255	120	300	285	60
320	255	100	320	255	140	320	285	80
340	285	90	340	285	130	340	285	100
360	285	110	360	285	150	360	335	70
380	285	130	380	285	170	380	335	90

## Łącznik izolacyjny do betonu, TORX 25

Insulation screws for concrete construction

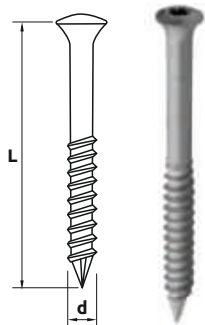

INDEX	ROZMIAR SIZE [mm]	ILOŚĆ [szt.] QUANTITY [pcs]	CENA / PRICE 1000 szt./pcs [PLN]
GTHD-63060	6,3 x 60	500	437,33
GTHD-63070	6,3 x 70	500	504,71
GTHD-63080	6,3 x 80	500	572,26
GTHD-63090	6,3 x 90	500	672,53
GTHD-63100	6,3 x 100	500	772,60
GTHD-63130	6,3 x 130	500	1078,30
GTHD-63160	6,3 x 160	500	1593,50
GTHD-63180	6,3 x 180	500	2173,50
GTHD-63200	6,3 x 200	500	2659,50
GTHD-63220	6,3 x 220	500	3326,30
GTHD-63250	6,3 x 250	500	4114,50
GTHD-63280	6,3 x 280	500	5515,60
GTHD-63300	6,3 x 300	500	5827,80

## Wkręty do blach odporne na korozję, 15 cykli Kesternicha przewiercalność max. 0,9 mm

Self-drilling flat head window screw for steel assembly



INDEX	ROZMIAR SIZE [mm]	ILOŚĆ [szt.] QUANTITY [pcs]	CENA / PRICE 1000 szt./pcs [PLN]
EDSS-48050	4,8 x 50	1000	157,40
EDSS-48060	4,8 x 60	500	191,26
EDSS-48070	4,8 x 70	500	218,59
EDSS-48080	4,8 x 80	500	308,86
EDSS-48090	4,8 x 90	500	343,21
EDSS-48100	4,8 x 100	500	389,44
EDSS-48110	4,8 x 110	500	462,65
EDSS-48120	4,8 x 120	500	505,92
EDSS-48130	4,8 x 130	500	599,92
EDSS-48140	4,8 x 140	500	667,07
EDSS-48150	4,8 x 150	500	786,45
EDSS-48160	4,8 x 160	500	975,93
EDSS-48180	4,8 x 180	500	1 498,21
EDSS-48200	4,8 x 200	500	1 989,10
EDSS-48220	4,8 x 220	500	2 948,55
EDSS-48240	4,8 x 240	500	4 179,08
EDSS-48260	4,8 x 260	500	5 777,70

## Wkręt do blach odporny na korozję, 15 cykli Kesternicha przewiercalność max. 1,25 mm

Self-drilling flat head window screw for steel assembly



INDEX	ROZMIAR SIZE [mm]	ILOŚĆ [szt.] QUANTITY [pcs]	CENA / PRICE 1000 szt./pcs [PLN]
EDSB-48050	4,8 x 40	1000	201,56
EDSB-48050	4,8 x 50	1000	229,54
EDSB-48060	4,8 x 60	1000	303,85
EDSB-48070	4,8 x 70	1000	338,83
EDSB-48080	4,8 x 80	1000	465,56
EDSB-48090	4,8 x 90	1000	531,21
EDSB-48100	4,8 x 100	500	601,34
EDSB-48110	4,8 x 110	500	707,35
EDSB-48120	4,8 x 120	500	778,97
EDSB-48130	4,8 x 130	500	1 002,79
EDSB-48140	4,8 x 140	500	1 143,05
EDSB-48150	4,8 x 150	500	1 434,03

## Łącznik do dachów betonowych

Plug for concrete roofs



INDEX	ROZMIAR SIZE [mm]	ILOŚĆ [szt.] QUANTITY [pcs]	CENA / PRICE 1000 szt./pcs [PLN]
KKW-08L60	8 x 60	200 2400	47,00

## Gwoździe utwardzane

Hardened steel nails white zinc plated



INDEX	ROZMIAR SIZE [mm]	ILOŚĆ [szt.] QUANTITY [pcs]		CENA / PRICE 100 szt./pcs [PLN]
GU-030	3,0 x 30	100	3000	7,19
GU-040	3,0 x 40	100	3000	7,82
GU-050	3,0 x 50	100	1200	10,23
GU-060	3,0 x 60	100	1200	11,09
GU-070	3,0 x 70	100	1200	13,17
GU-080	3,0 x 80	100	1200	14,67
GU-085	3,5 x 85	100	800	19,11
GU-100	3,5 x 100	100	800	22,70
GU-125	4,0 x 125	100	800	44,85

## Gwoździe utwardzane walcowane

Hardened steel nail grooved shank white zinc plated



INDEX	ROZMIAR SIZE [mm]	ILOŚĆ [szt.] QUANTITY [pcs]		CENA / PRICE 250 szt./pcs [PLN]
GUW-20	2,7 x 20	250	3000	11,10
GUW-25	2,7 x 25	250	3000	12,22
GUW-30	2,7 x 30	250	3000	13,38
GUW-40	2,7 x 40	250	3000	16,29
GUW-41	3,5 x 40	250	3000	22,70
GUW-50	3,5 x 50	250	3000	26,50
GUW-60	3,5 x 60	250	3000	32,00
GUW-70	4,5 x 70	250	1500	59,50

## Gwoździe utwardzane walcowane z podkładką

Hardened steel nail grooved shank with washer white zinc plated



INDEX	ROZMIAR SIZE [mm]	ILOŚĆ [szt.] QUANTITY [pcs]		CENA / PRICE 250 szt./pcs [PLN]
GUP-20	3,5 x 20	250	3000	32,50
GUP-25	3,5 x 25	250	3000	43,23
GUP-30	3,5 x 30	250	3000	47,56
GUP-35	3,5 x 35	250	3000	53,23
GUP-40	3,5 x 40	250	2000	62,78
GUP-50	3,5 x 50	250	2000	64,22
GUP-65	3,5 x 65	250	1500	97,34
GUP-70	3,5 x 70	250	1500	134,00

## Gwoździe stolarskie - ocynkowane

Finishing nail, yellow zinc plated

DIN 1152



INDEX	ROZMIAR SIZE [mm]	ILOŚĆ QUANTITY [kg]		CENA / PRICE 1kg [PLN]
GSO-1420	1,4 x 20	1	25	14,00
GSO-1425	1,4 x 25	1	25	14,00
GSO-1630	1,6 x 30	1	25	14,00
GSO-1835	1,8 x 35	1	25	14,00
GSO-2040	2,0 x 40	1	25	14,00
GSO-2250	2,2 x 50	1	25	14,00
GSO-2560	2,5 x 60	1	25	14,00

## Gwoździe stolarskie - miedziane

Finishing nail, copper plated

DIN 1152



INDEX	ROZMIAR SIZE [mm]	ILOŚĆ QUANTITY [kg]		CENA / PRICE 1kg [PLN]
GSM-1420	1,4 x 20	1	25	16,80
GSM-1425	1,4 x 25	1	25	16,80
GSM-1630	1,6 x 30	1	25	16,80
GSM-1835	1,8 x 35	1	25	16,80
GSM-2040	2,0 x 40	1	25	16,80
GSM-2250	2,2 x 50	1	25	16,80
GSM-2560	2,5 x 60	1	25	16,80

## Gwoździe budowlane czarne

Common nails



INDEX	ROZMIAR SIZE [mm]	CENA / PRICE	
		1kg [PLN]	1kg (opak./box 5kg) [PLN]
<b>GWBU-2040</b>	2,0 x 40	-	7,00
<b>GWBU-2250</b>	2,2 x 50	7,40	6,60
<b>GWBU-2560</b>	2,5 x 60	7,30	6,30
<b>GWBU-3070</b>	3,0 x 70	7,00	6,10
<b>GWBU-3080</b>	3,0 x 80	7,00	6,10
<b>GWBU-3590</b>	3,5 x 90	7,00	6,10
<b>GWBU-40100</b>	4,0 x 100	7,00	6,10
<b>GWBU-45125</b>	4,5 x 125	7,00	6,10
<b>GWBU-50150</b>	5,0 x 150	7,00	6,10
<b>GWBU-60175</b>	6,0 x 175	-	6,50
<b>GWBU-60200</b>	6,0 x 200	-	6,50
<b>GWBU-70225</b>	7,0 x 225	-	6,50
<b>GWBU-80250</b>	8,0 x 250	-	6,50
<b>GWBU-80275</b>	8,0 x 275	-	6,50
<b>GWBU-80300</b>	8,0 x 300	-	6,50

## Gwoździe "ANCHOR" ocynkowane elektrolitycznie, do mocowania elementów złącz ciesielskich, różnych elementów drewnianych oraz haków dachowych do konstrukcji drewnianych.

Steel nails "Anchor" electro white zinc plated



INDEX	ROZMIAR SIZE [mm]	ILOŚĆ QUANTITY [kg]		CENA / PRICE 1kg [PLN]
<b>GKA-4035</b>	4,0 x 35	1	12	10,90
<b>GKA-4040</b>	4,0 x 40	1	12	10,90
<b>GKA-4050</b>	4,0 x 50	1	12	10,90
<b>GKA-4060</b>	4,0 x 60	1	12	10,90
<b>GKA-4075</b>	4,0 x 75	1	8	10,90
<b>GKA-4100</b>	4,0 x 100	1	8	10,90
<b>GKA-4125</b>	4,0 x 125	1	8	10,90

## Gwoździe papowe z podkładką do zamocowań pap izolacyjnych, cienkich blach / Podkładka do gwoździ papowych

Roofing nails with washers / Washer for nails



INDEX	ROZMIAR SIZE [mm]	KOLOR COLOR	ILOŚĆ QUANTITY [kg]		CENA / PRICE 1kg [PLN]
<b>GWPAP3025</b>	3,0 X 25	ocynk / zinc	5	20	14,10
<b>GWPAP3030</b>	3,0 X 30	ocynk / zinc	5	20	13,90
<b>PODPAP</b>	ø26	ocynk / zinc	5	20	12,00

## Gwoździe papowe do zamocowań pap izolacyjnych, cienkich blach

Roofing nails



INDEX	ROZMIAR SIZE [mm]	KOLOR COLOR	ILOŚĆ QUANTITY [kg]		CENA / PRICE 1kg [PLN]
<b>GWPA3020</b>	3,0 X 20	ocynk / zinc	5	20	10,50
<b>GWPA3020cz</b>	3,0 X 20	czarne / black	5	20	9,50
<b>GWPA3025</b>	3,0 X 25	ocynk / zinc	5	20	10,50
<b>GWPA3025cz</b>	3,0 X 25	czarne / black	5	20	9,50
<b>GWPA3030</b>	3,0 X 30	ocynk / zinc	5	20	10,50
<b>GWPA3030cz</b>	3,0 X 30	czarne / black	5	20	9,50
<b>GWPA3035</b>	3,0 X 35	ocynk / zinc	5	20	10,50
<b>GWPA3035cz</b>	3,0 X 35	czarne / black	5	20	9,50
<b>GWPA3040</b>	3,0 X 40	ocynk / zinc	5	20	10,30
<b>GWPA3040cz</b>	3,0 X 40	czarne / black	5	20	9,30

## Gwoździe skrętnie ocynkowane ogniwo o podwyższonej sile wyciągania do mocowania gontów bitumicznych oraz fasad z tworzyw sztucznych do konstrukcji drewnianych

Square twisted nails



INDEX	ROZMIAR SIZE [mm]	ILOŚĆ QUANTITY [kg]	CENA / PRICE	
			1 kg [PLN]	1 kg (opak. 5kg / box 5kg) [PLN]
GWS-030	3,5 x 30	5	29,00	28,00
GWS-040	3,5 x 40	5	29,00	28,00
GWS-080	3,0 x 80	5	29,00	28,00
GWS-090	3,0 x 90	5	29,00	28,00
GWS-100	4,0 x 100	5	29,00	28,00
GWS-125	4,5 x 125	5	29,00	28,00
GWS-150	4,5 x 150	5	29,00	28,00

## Gwoździe SKOBLE do montażu siatki

U-nails



INDEX	ROZMIAR SIZE [mm]	KOLOR COLOR	ILOŚĆ QUANTITY [kg]		CENA / PRICE 1 kg [PLN]
			1 kg	5 kg	
SKO2525S	2,5 x 25	ocynk / zinc	5	20	12,83
SKO3030S	3,0 x 30	ocynk / zinc	5	20	12,13
SKO3035S	3,0 x 35	ocynk / zinc	5	20	12,13
SKO3540S	3,5 x 40	ocynk / zinc	5	20	12,13

## Błachowkręt samowiertny z gniazdem kwadratowym

Square pan head, self drilling screw, hardened, zinc plated

DIN 7504 V HEX

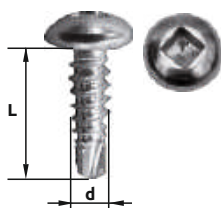

INDEX	ROZMIAR SIZE [mm] d x L	GNAZDO NEST	MAKSYMALNA PRZEWIERCALNOŚĆ DRILLING CAPACITY [mm]	ILOŚĆ [szt.] QUANTITY [pcs]	CENA / PRICE 1 000 szt. / pcs. [PLN]
WMW-4213	4,2 x 13	R2	3,0	1000	33,80
WMW-4216	4,2 x 16	R2	3,0	1000	37,00
WMW-4219	4,2 x 19	R2	3,0	1000	43,00

## Błachowkręt samowiertny z łbem walcowym PH

Pan head sheet metal screw

DIN 7504 N



INDEX	ROZMIAR SIZE [mm] d x L	GNAZDO NEST	MAKSYMALNA PRZEWIERCALNOŚĆ DRILLING CAPACITY [mm]	ILOŚĆ [szt.] QUANTITY [pcs]	CENA / PRICE 1 000 szt. / pcs. [PLN]
OCS-3911	3,9 x 11	PH2	2,25	1000	29,70
OCS-3913	3,9 x 13	PH2	2,25	1000	33,00
OCS-3916	3,9 x 16	PH2	2,25	1000	36,00
OCS-3919	3,9 x 19	PH2	2,25	1000	39,00
OCS-3925	3,9 x 25	PH2	2,25	1000	45,50
OCS-3932	3,9 x 32	PH2	2,25	1000	54,00
OCS-4213	4,2 x 13	PH2	3,0	1000	36,00
OCS-4216	4,2 x 16	PH2	3,0	1000	40,00
OCS-4219	4,2 x 19	PH2	3,0	1000	43,50
OCS-4225	4,2 x 25	PH2	3,0	1000	50,50
OCS-4232	4,2 x 32	PH2	3,0	1000	60,00
OCS-4238	4,2 x 38	PH2	3,0	1000	71,50
OCS-4813	4,8 x 13	PH2	4,0	500	49,00
OCS-4816	4,8 x 16	PH2	4,0	500	53,00
OCS-4819	4,8 x 19	PH2	4,0	500	58,00
OCS-4825	4,8 x 25	PH2	4,0	500	68,00
OCS-4832	4,8 x 32	PH2	4,0	500	80,00
OCS-4838	4,8 x 38	PH2	4,0	500	88,00

### Podkładka EPDM

EPDM Washer

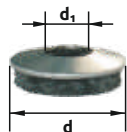

INDEX	ŚREDNICA DIAMETER [mm] d	ŚREDNICA WKRETA SCREW DIAMETER [mm] d <sub>1</sub>	ILOŚĆ [szt.] QUANTITY [pcs]	CENA / PRICE 1 000 szt. / pcs. [PLN]
EPDM-12	12	4,2	1000	47,00
EPDM-14	14	4,8	1000	49,00
EPDM-16	16	5,5	1000	52,00
EPDM-19	19	6,3	500	79,62
EPDM-25	25	8,0	250	153,00

### Wkręt samowiertny do mocowania blach do konstrukcji stalowej bez podkładki

Self drilling screws, hex washer head, hardened, zinc plated

DIN 7504 K

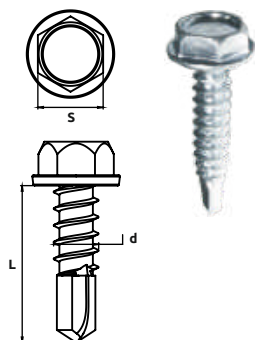

INDEX	ROZMIAR SIZE [mm]			MAKSYMALNA PRZEWIERCALNOŚĆ DRILLING CAPACITY [mm]	ILOŚĆ [szt.] QUANTITY [pcs]		CENA / PRICE 1 000 szt. / pcs. [PLN]
	d	L	s		1000 szt.	250 szt.	
OC-42013	4,2	13	7	2,5	250	6000	42,98
OC-42016	4,2	16	7	2,5	250	6000	45,22
OC-42019	4,2	19	7	2,5	250	6000	49,23
OC-42025	4,2	25	7	2,5	250	6000	51,10
OC-42032	4,2	32	7	2,5	250	3000	67,00
OC-42038	4,2	38	7	2,5	250	3000	89,00
OC-48013	4,8	13	7	3,0	250	6000	61,45
OC-48016	4,8	16	8	3,0	250	6000	62,92
OC-48019	4,8	19	8	3,0	250	6000	69,74
OC-48022	4,8	22	8	3,0	250	6000	72,30
OC-48025	4,8	25	8	3,0	250	6000	76,74
OC-48032	4,8	32	8	3,0	250	3000	88,83
OC-48035	4,8	35	8	3,0	250	3000	92,95
OC-48038	4,8	38	8	3,0	250	3000	99,08
OC-48045	4,8	45	8	3,0	250	3000	111,17
OC-48055	4,8	55	8	3,0	250	3000	129,60
OC-55019	5,5	19	8	5,0	250	6000	85,15
OC-55022	5,5	22	8	5,0	250	3000	90,27
OC-55025	5,5	25	8	5,0	250	3000	97,39
OC-55032	5,5	32	8	5,0	250	3000	113,64
OC-55035	5,5	35	8	5,0	250	3000	121,52
OC-55038	5,5	38	8	5,0	250	3000	125,61
OC-55045	5,5	45	8	5,0	250	3000	136,30
OC-55050	5,5	50	8	5,0	250	3000	148,24
OC-55063	5,5	63	8	5,0	250	3000	176,79
OC-55075	5,5	75	8	5,0	200	2400	206,21
OC-55090	5,5	90	8	5,0	100	1200	280,52
OC-55120	5,5	120	8	5,0	100	1200	441,58
OC-63019	6,3	19	10	6,0	250	3000	128,25
OC-63025	6,3	25	10	6,0	250	3000	141,00
OC-63032	6,3	32	10	6,0	250	3000	161,37
OC-63038	6,3	38	10	6,0	250	3000	186,97
OC-63050	6,3	50	10	6,0	250	3000	220,85
OC-63063	6,3	63	10	6,0	200	2400	258,18
OC-63075	6,3	75	10	6,0	100	1200	302,78
OC-55024_8	5,5	24	8	8,0	250	3000	201,00
OC-55032_12	5,5	32	8	12,0	250	3000	215,00
OC-55035_12	5,5	35	8	12,0	250	3000	227,00
OC-55038_12	5,5	38	8	12,0	250	3000	243,00
OC-55050_12	5,5	50	8	12,0	250	3000	280,00
OC-55067_12	5,5	67	8	12,0	200	2400	367,00

\* możliwość lakierowania w dowolnym kolorze wg palety RAL, koszt lakierowania 40 PLN/1000 sztuk

## Wkręt samowiertny do mocowania blach do konstrukcji stalowej, z podkładką EPDM

Self-drilling roofing screw with EPDM washer



INDEX	ROZMIAR SIZE [mm]	MAKSYMALNA PRZEWIERCALNOŚĆ DRILLING CAPACITY [mm]	ILOŚĆ [szt.] QUANTITY [pcs]		CENA / PRICE 1 000 szt. / pcs. [PLN]
OCG-48016	4,8 x 16	3,0	250	3000	102,94
OCG-48019	4,8 x 19	3,0	250	3000	105,94
OCG-48022	4,8 x 22	3,0	250	3000	110,79
OCG-48025	4,8 x 25	3,0	250	3000	115,42
OCG-48032	4,8 x 32	3,0	250	3000	121,09
OCG-48035	4,8 x 35	3,0	250	3000	125,00
OCG-48038	4,8 x 38	3,0	250	3000	143,24
OCG-48045	4,8 x 45	3,0	250	3000	156,45
OCG-48055	4,8 x 55	3,0	250	3000	167,34
OCG-55019	5,5 x 19	5,0	250	3000	158,29
OCG-55022	5,5 x 22	5,0	250	3000	164,44
OCG-55025	5,5 x 25	5,0	250	3000	172,98
OCG-55032	5,5 x 32	5,0	250	3000	192,47
OCG-55035	5,5 x 35	5,0	250	3000	201,93
OCG-55038	5,5 x 38	5,0	250	3000	206,84
OCG-55045	5,5 x 45	5,0	250	3000	219,67
OCG-55050	5,5 x 50	5,0	250	3000	234,00
OCG-55063	5,5 x 63	5,0	200	2400	268,25
OCG-55075	5,5 x 75	5,0	100	1200	303,56
OCG-55090	5,5 x 90	5,0	100	1200	392,73
OCG-55120	5,5 x 120	5,0	50	600	586,00
OCG-63019	6,3 x 19	6,0	250	3000	231,49
OCG-63022	6,3 x 22	6,0	250	3000	239,15
OCG-63025	6,3 x 25	6,0	250	3000	246,80
OCG-63032	6,3 x 32	6,0	250	3000	271,24
OCG-63038	6,3 x 38	6,0	250	2400	304,29
OCG-63050	6,3 x 50	6,0	100	1200	327,27
OCG-63063	6,3 x 63	6,0	100	1200	385,78
OCG-63075	6,3 x 75	6,0	50	600	421,78

\* możliwość lakierowania w dowolnym kolorze wg palety RAL, koszt lakierowania 40 PLN/1000 sztuk

## Wkręt samowiertny do mocowania blach do konstrukcji stalowej, z podkładką EPDM

Self-drilling roofing inch screw with EPDM washer



INDEX	ROZMIAR SIZE [mm]	MAKSYMALNA PRZEWIERCALNOŚĆ DRILLING CAPACITY [mm]	ILOŚĆ [szt.] QUANTITY [pcs]		CENA / PRICE 1 000 szt. / pcs. [PLN]
OCG-55024_8	5,5 x 24	8,0	250	3000	232,00
OCG-55032_12	5,5 x 32	12,0	250	3000	240,00
OCG-55035_12	5,5 x 35	12,0	250	3000	295,00
OCG-55038_12	5,5 x 38	12,0	250	3000	310,00
OCG-55050_12	5,5 x 50	12,0	250	3000	350,00
OCG-55067_12	5,5 x 67	12,0	100	1200	367,00

\* możliwość lakierowania w dowolnym kolorze wg palety RAL, koszt lakierowania 40 PLN/1000 sztuk

## Wkręt samowiertny do mocowania płyt warstwowych do konstrukcji stalowych, maksymalna przewiercalność 6 mm z podkładką EPDM

Self-drilling roofing distance inch screw with EPDM washer

AT-15-7794/2015



INDEX	ROZMIAR SIZE [mm]	MAKSYMALNA PRZEWIERCALNOŚĆ DRILLING CAPACITY [mm]	ILOŚĆ [szt.] QUANTITY [pcs]		CENA / PRICE 1 000 szt. / pcs. [PLN]
OWG-06065	5,5 x 65	6	50		548,00
OWG-06090	5,5 x 90	6	50		628,00
OWG-06110	5,5 x 110	6	50		726,00
OWG-06125	5,5 x 125	6	50		838,00
OWG-06150	5,5 x 150	6	50		1 053,00
OWG-06175	5,5 x 175	6	50		1 500,00
OWG-06200	5,5 x 200	6	50		1 936,00
OWG-06230	5,5 x 230	6	50		2 705,00
OWG-06285	5,5 x 285	6	50		4 560,00

**Wkręt samowiertny do mocowania płyt warstwowych do konstrukcji stalowych, maksymalna przewiercalność 12 mm z podkładką EPDM**

Self-drilling roofing distance inch screw with EPDM washer

AT-15-7794/2015



INDEX	ROZMIAR SIZE [mm]	MAKSYMALNA PRZEWIERCALNOŚĆ DRILLING CAPACITY [mm]	ILOŚĆ [szt.] QUANTITY [pcs]	CENA / PRICE 1 000 szt. / pcs. [PLN]
OWG-12070	5,5 x 70	12	50	663,23
OWG-12090	5,5 x 90	12	50	767,70
OWG-12110	5,5 x 110	12	50	882,50
OWG-12130	5,5 x 130	12	50	1 077,92
OWG-12150	5,5 x 150	12	50	1 270,00
OWG-12175	5,5 x 175	12	50	1 606,00
OWG-12185	5,5 x 185	12	50	1 843,00
OWG-12200	5,5 x 200	12	50	2 120,00
OWG-12230	5,5 x 230	12	50	3 479,90
OWG-12285	5,5 x 285	12	50	4 867,00

**Wkręt do mocowania płyt warstwowych do konstrukcji betonowych z podkładką EPDM**

Self-drilling roofing distance inch screw with EPDM washer



INDEX	ROZMIAR SIZE [mm]	ILOŚĆ [szt.] QUANTITY [pcs]	CENA / PRICE 1 000 szt. / pcs. [PLN]
OWB-64100	6,4 x 100	100	1157,50
OWB-64120	6,4 x 120	100	1215,40
OWB-64140	6,4 x 140	100	1273,30
OWB-64160	6,4 x 160	100	1504,80
OWB-64190	6,4 x 190	100	2390,00
OWB-64210	6,4 x 210	100	2731,70
OWB-64240	6,4 x 240	100	3617,50
OWB-64260	6,4 x 260	100	4167,10
OWB-64280	6,4 x 280	100	4723,50
OWB-64310	6,4 x 310	100	6284,00

**Wkręt farmerski GUNNEBO typu PAN HEAD - do mocowania profilowanych blach stalowych do konstrukcji drewnianych, z podkładką aluminiową EPDM**

Panhead farmer screw (for sheet metal and wood)



INDEX	ROZMIAR SIZE [mm]	KOLOR COLOR	ILOŚĆ [szt.] QUANTITY [pcs]	CENA / PRICE 1 opak. / 1 box [PLN]
FTX-20 OC	4,8 x 20	ocynk / zinc	250	75,00
FTX-20 RAL	4,8 x 20	RAL	250	75,00
FTX-35 OC	4,8 x 35	ocynk / zinc	250	75,00
FTX-35 RAL	4,8 x 35	RAL	250	75,00

**Wkręt farmerski GUNNEBO OFA - do mocowania profilowanych blach stalowych do konstrukcji drewnianych, z podkładką stalową S-14 z podkładką EPDM**

Self-drilling farmer screw with EPDM washer



INDEX	ROZMIAR SIZE [mm]	KOLOR COLOR	ILOŚĆ [szt.] QUANTITY [pcs]	CENA / PRICE 1 opak. / 1 box [PLN]
OD-20OC	4,8 x 20	ocynk / zinc	250	26,60
OD-20OC RAL	4,8 x 20	RAL	250	28,60
OD-35OC	4,8 x 35	ocynk / zinc	250	26,60
OD-35OC RAL	4,8 x 35	RAL	250	28,60
OD-50OC	4,8 x 50	ocynk / zinc	100	23,00
OD-50OC RAL	4,8 x 50	RAL	100	25,00
OD-60OC	4,8 x 60	ocynk / zinc	100	25,00
OD-60OC RAL	4,8 x 60	RAL	100	27,00
OD-70OC	4,8 x 70	ocynk / zinc	100	30,00
OD-70OC RAL	4,8 x 70	RAL	100	32,00
OD-80OC	4,8 x 80	ocynk / zinc	100	35,00
OD-80OC RAL	4,8 x 80	RAL	100	37,00
OD-99OC	4,8 x 100	ocynk / zinc	100	38,00
OD-99OC RAL	4,8 x 100	RAL	100	40,00

**DOSTĘPNE KOLORY**  
**COLOURS AVAILABLE:**

 RAL 3005, RAL 3009, RAL 3011,  
 RAL 5010, RAL 6020, RAL 7024,  
 RAL 8004, RAL 8017, RAL 8019,  
 RAL 9005, RAL 9006, RAL 9010

## Wkręt farmerski do mocowania profilowanych blach stalowych do konstrukcji drewnianych, z podkładką EPDM

Self-drilling farmer screw with EPDM washer



### DOSTĘPNE KOLORY

COLOURS AVAILABLE:

RAL 3005, RAL 3009, RAL 3011, RAL 5010, RAL 6020, RAL 7024, RAL 8004, RAL 8017, RAL 8019, RAL 9005, RAL 9006, RAL 9010

INDEX	ROZMIAR SIZE [mm]	KOLOR COLOR	ILOŚĆ [szt.] QUANTITY [pcs]	CENA / PRICE 1 opak. / 1 box [PLN]
ODI20	4,8 x 20	ocynk / zinc	250	25,60
ODI20 RAL	4,8 x 20	RAL	250	27,60
ODI35	4,8 x 35	ocynk / zinc	250	25,60
ODI35 RAL	4,8 x 35	RAL	250	27,60
ODI50	4,8 x 50	ocynk / zinc	100	21,00
ODI50 RAL	4,8 x 50	RAL	100	23,00
ODI60	4,8 x 60	ocynk / zinc	100	23,00
ODI60 RAL	4,8 x 60	RAL	100	24,00
ODI70	4,8 x 70	ocynk / zinc	100	28,00
ODI70 RAL	4,8 x 70	RAL	100	29,00
ODI80	4,8 x 80	ocynk / zinc	100	32,00
ODI80 RAL	4,8 x 80	RAL	100	33,00
ODI99	4,8 x 100	ocynk / zinc	100	35,00
ODI99 RAL	4,8 x 100	RAL	100	38,00

## Farba zaprawkowa

Spray primers



INDEX	RAL	KOLOR COLOR	CENA / PRICE 400 ml [PLN]
FA-1002	1002	Jasny żółty / Light yellow	44,00
FA-1015	1015	Kość słoniowa / Ivory	44,00
FA-1032	1032	Żółty / Yellow	44,00
FA-3005	3005	Wiśniowy / Cherry	44,00
FA-3009	3009	Ciemny czerwony / Dark red	44,00
FA-3011	3011	Czerwony / Red	44,00
FA-3016	3016	Czerwony / Red	44,00
FA-5010	5010	Niebieski / Blue	44,00
FA-6020	6020	Zielony / Green	44,00
FA-6029	6029	Zielony / Green	44,00
FA-7024	7024	Ciemny szary / Dark grey	44,00
FA-7032	7032	Jasny szary / Light grey	44,00
FA-8004	8004	Ceglasty / Brick red	44,00
FA-8011	8011	Brązowy / Brown	44,00
FA-8014	8014	Brązowy / Brown	44,00
FA-8017	8017	Brązowy / Brown	44,00
FA-9005	9005	Czarny / Black	44,00
FA-9006	9006	Srebrny / Silver	44,00
FA-9010	9010	Biały / White	44,00

## Kółnierz uszczelniający

Sealing collar



Kółnierz wykonany z EPDM wzmocnionego taśmą aluminiową. Przeznaczony do uszczelnienia przelotów różnego rodzaju instalacji budynku (jak kominy, wentylacje, rury itp.) w elewacjach oraz dachach wykonanych z blach profilowanych.

INDEX	RODZAJ TYPE	ŚREDNICA OTWORU HOLE DIAMETER [mm]	CENA / PRICE 1 szt. / pcs [PLN]
MF-1	EPDM 1	6 - 50	47,25
MF-2	EPDM 2	32 - 76	60,38
MF-3	EPDM 3	60 - 102	66,35
MF-4	EPDM 4	76 - 152	107,60
MF-5	EPDM 5	102 - 178	126,00
MF-6	EPDM 6	127 - 228	134,60
MF-7	EPDM 7	152 - 280	173,08
MF-8	EPDM 8	178 - 330	208,10
MF-9	EPDM 9	254 - 467	742,80

## Nit zrywalny Al / Fe

Open type blind rivet with dome head - white zinc Al/Fe



\* - możliwość lakierowania  
w dowolnym kolorze wg palety RAL  
- koszt lakierowania 30 PLN / 1000 sztuk

INDEX	ROZMIAR / SIZE d x L [mm]	ILOŚĆ [szt./kg] QUANTITY [psc/kg]	ILOŚĆ [kg] QUANTITY [kg]	CENA / PRICE 1 kg [PLN]
NIT-306	3 x 6	1152	10	18,72
NIT-308	3 x 8	1148	10	18,72
NIT-310	3 x 10	1000	10	18,72
NIT-312	3 x 12	964	10	18,72
NIT-406	4 x 6	624	10	16,50
NIT-408	4 x 8	618	10	16,50
NIT-410	4 x 10	602	10	16,50
NIT-412	4 x 12	552	10	16,50
NIT-414	4 x 14	521	10	16,50
NIT-416	4 x 16	506	10	16,50
NIT-418	4 x 18	500	10	16,50
NIT-420	4 x 20	452	10	16,50
NIT-506	5 x 6	401	10	16,00
NIT-508	5 x 8	380	10	16,00
NIT-510	5 x 10	365	10	16,00
NIT-512	5 x 12	353	10	16,00
NIT-514	5 x 14	327	10	16,00
NIT-516	5 x 16	320	10	16,00
NIT-518	5 x 18	291	10	16,00
NIT-520	5 x 20	284	10	16,00
NIT-522	5 x 22	270	10	16,00
NIT-524	5 x 24	262	10	16,50
NIT-526	5 x 26	251	10	16,50
NIT-530	5 x 30	240	10	16,50
NIT-610	6 x 10	234	10	17,00
NIT-612	6 x 12	226	10	17,00
NIT-614	6 x 14	207	10	17,00
NIT-616	6 x 16	199	10	17,00
NIT-618	6 x 18	194	10	17,00
NIT-620	6 x 20	189	10	17,00

## Nit zrywalny stal nierdzewna A2 (INOX/INOX)

Open type blind rivet with dome head - A2 INOX



INDEX	ROZMIAR / SIZE d x L [mm]	ILOŚĆ [szt.] QUANTITY [pcs]	CENA / PRICE 1 kg [PLN]
NITN-3006	3,0 x 6	1000	130,91
NITN-3008	3,0 x 8	1000	163,64
NITN-3010	3,0 x 10	1000	167,27
NITN-3012	3,0 x 12	1000	181,82
NITN-4006	4,0 x 6	500	163,64
NITN-4008	4,0 x 8	500	203,64
NITN-4010	4,0 x 10	500	207,27
NITN-4012	4,0 x 12	500	229,09
NITN-4014	4,0 x 14	500	243,64
NITN-4016	4,0 x 16	500	247,27
NITN-4806	4,8 x 6	500	192,73
NITN-4808	4,8 x 8	500	240,00
NITN-4810	4,8 x 10	500	243,64
NITN-4812	4,8 x 12	500	269,09
NITN-4814	4,8 x 14	500	287,27
NITN-4816	4,8 x 16	500	290,91
NITN-4825	4,8 x 25	500	436,36

## Nit zrywalny Al / Fe lakierowany

Open type blind rivet with dome head - Al/Fe

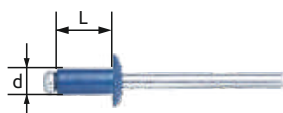

INDEX	ROZMIAR / SIZE d x L [mm]	ILOŚĆ [szt./kg] QUANTITY [psc/kg]	ILOŚĆ [szt.] QUANTITY [pcs]	CENA / PRICE 1 kg [PLN]
NITL510 RAL	5 x 10	365	500	163,00

DOSTĘPNE KOLORY / AVAILABLE COLOURS:

RAL1002, RAL3005, RAL3009, RAL3011, RAL6020, RAL7016, RAL7024, RAL8003, RAL8004, RAL8017, RAL9004, RAL9005, RAL9006, RAL9010

## Nit zrywalny Fe / Fe

Open type blind rivet with dome head - Fe/Fe

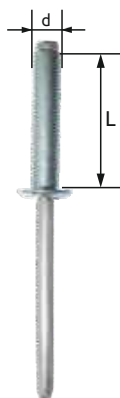

INDEX	ROZMIAR / SIZE d x L [mm]	ILOŚĆ [szt.] QUANTITY [pcs]	CENA / PRICE 1000 szt./pcs [PLN]
NITS-3006	3,0 x 6	1000	47,90
NITS-3008	3,0 x 8	1000	53,80
NITS-3010	3,0 x 10	1000	61,00
NITS-3012	3,0 x 12	1000	68,80
NITS-3206	3,2 x 6	1000	53,40
NITS-3210	3,2 x 10	1000	80,10
NITS-4006	4,0 x 6	500	60,70
NITS-4008	4,0 x 8	500	73,40
NITS-4010	4,0 x 10	500	84,10
NITS-4012	4,0 x 12	500	95,90
NITS-4014	4,0 x 14	500	101,30
NITS-4016	4,0 x 16	500	106,70
NITS-4018	4,0 x 18	500	113,30
NITS-4020	4,0 x 20	500	121,20
NITS-4806	4,8 x 6	500	82,30
NITS-4808	4,8 x 8	500	87,60
NITS-4810	4,8 x 10	500	98,10
NITS-4812	4,8 x 12	500	104,30
NITS-4814	4,8 x 14	500	126,70
NITS-4816	4,8 x 16	500	138,40
NITS-4818	4,8 x 18	500	152,70
NITS-4820	4,8 x 20	500	162,10
NITS-4824	4,8 x 24	500	227,22

## Nit zrywalny miedziano-stalowy Cu / Fe

Open type blind rivet with dome head - Cu/Fe

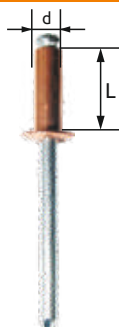

INDEX	ROZMIAR / SIZE d x L [mm]	ILOŚĆ [szt.] QUANTITY [pcs]	CENA / PRICE 1000 szt./pcs [PLN]
NITMS-4006	4,0 x 6	500	120,70
NITMS-4008	4,0 x 8	500	140,00
NITMS-4010	4,0 x 10	500	174,37
NITMS-4012	4,0 x 12	500	203,43
NITMS-4806	4,8 x 6	500	177,83
NITMS-4808	4,8 x 8	500	180,00
NITMS-4810	4,8 x 10	500	183,70
NITMS-4812	4,8 x 12	500	261,57

## Nitonakrętka stalowa

Rivet nut

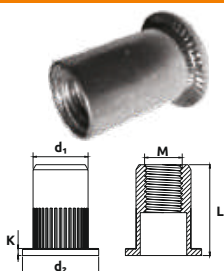

INDEX	ROZMIAR SIZE [mm]					ILOŚĆ [szt.] QUANTITY [pcs]		CENA / PRICE 1000 szt./pcs [PLN]
	M	L	d <sub>1</sub>	d <sub>2</sub>	K			
NITONA-04	M4	11	6	9,0	0,90	500	4000	178,00
NITONA-05	M5	13	7	10,0	1,00	500	4000	222,00
NITONA-06	M6	15	9	12,2	1,20	250	1500	243,00
NITONA-08	M8	18	11	14,8	1,45	250	1500	289,50
NITONA-10	M10	21	13	17,1	1,80	150	900	537,67
NITONA-12	M12	25	15	19,0	1,90	100	600	1 112,11

## Nitownice K2 Industrial Line / Hand riveter

INDEX	NAZWA / NAME	ZAKRES RANGE [mm]	DŁUGOŚĆ LENGTH [mm]	ILOŚĆ [szt.] QUANTITY [pcs]	CENA / PRICE 1000 szt./pcs [PLN]	
N-NIT01	Nitownica ręczna	2,4 - 5,0	200	1	5	64,57
N-NIT02	Nitownica dźwigniowa	3,0 - 6,0	320	1	16	88,61
N-NIT02-1	Nitownica teleskopowa	2,4 - 4,8	190	1	10	82,67
N-NIT03	Nitownica do nitonakrętek	M3 - M12	440	1	5	396,61
N-NIT03-1	Nitownica do nitonakrętek	M3 - M12	420	1	5	306,67

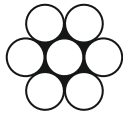

**Lina stalowa ocynkowana**  
 Steel wire ropes, galvanized

1x7

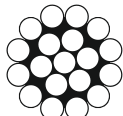

1x19

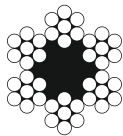

6x7

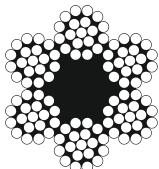

6x19

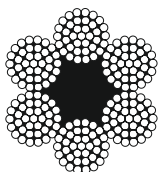

6x37

INDEX	ŚREDNICA DIAMETER [mm]	KONSTRUKCJA TYPE	SIŁA ZRYWAJĄCA BREAKING FORCE [kg]	DIN	ILOŚĆ QUANTITY [m] 	CENA / PRICE 1 mb [PLN]
LSZ01.107.0200	1,0	1x7	95	3052	200	0,18
LSZ01.119.0250	1,0	1x19	80	3053	250	0,22
LSZ015.119.0200	1,5	1x19	211	3053	200	0,32
LSZ015.119.1000	1,5	1x19	211	3053	1000	0,31
LSZ02.119.0250	2,0	1x19	375	3053	250	0,50
LSZ02.607.0200	2,0	6x7	269	3055	200	0,46
LSZ03.607.0200	3,0	6x7	529	3055	200	0,76
LSZ03.607.1000	3,0	6x7	529	3055	1000	0,74
LSZ04.607.0150	4,0	6x7	940	3055	150	1,66
LSZ04.619.0150	4,0	6x19	870	3060	150	2,10
LSZ04.619.0250	4,0	6x19	870	3060	250	2,10
LSZ04.619.1000	4,0	6x19	870	3060	1000	2,00
LSZ05.607.0150	5,0	6x7	1460	3055	150	2,64
LSZ05.619.0100	5,0	6x19	1360	3060	100	2,84
LSZ05.619.1000	5,0	6x19	1360	3060	1000	2,68
LSZ06.619.0100	6,0	6x19	1960	3060	100	3,74
LSZ06.619.0200	6,0	6x19	1960	3060	200	3,70
LSZ06.637.0100	6,0	6x37	2100	3066	200	4,58
LSZ08.619.0050	8,0	6x19	3480	3060	50	5,94
LSZ08.619.0100	8,0	6x19	3480	3060	100	5,92
LSZ08.619.0200	8,0	6x19	3480	3060	200	5,90
LSZ08.637.0050	8,0	6x37	3340	3066	50	6,10
LSZ08.637.0100	8,0	6x37	3340	3066	100	6,00
LSZ08.637.0200	8,0	6x37	3340	3066	200	5,94
LSZ08.637.0500	8,0	6x37	3340	3066	500	5,90
LSZ08.637.1000	8,0	6x37	3340	3066	1000	5,86
LSZ10.619.0050	10,0	6x19	5430	3060	50	9,18
LSZ10.619.0100	10,0	6x19	5430	3060	100	9,12
LSZ10.619.0200	10,0	6x19	5430	3060	200	8,98
LSZ10.619.0500	10,0	6x19	5430	3060	500	8,76
LSZ10.619.1000	10,0	6x19	5430	3060	1000	8,60
LSZ10.637.0050	10,0	6x37	5220	3066	50	9,78
LSZ10.637.0100	10,0	6x37	5220	3066	100	9,62
LSZ10.637.0200	10,0	6x37	5220	3066	200	9,50
LSZ10.637.0500	10,0	6x37	5220	3066	500	9,24
LSZ10.637.1000	10,0	6x37	5220	3066	1000	8,98
LSZ11.637.0050	11,0	6x37	6320	3066	50	12,80
LSZ12.619.0050	12,0	6x19	7820	3060	50	12,60
LSZ12.619.0100	12,0	6x19	7820	3060	100	13,42
LSZ12.619.0200	12,0	6x19	7820	3060	200	13,30
LSZ12.637.0050	12,0	6x37	7530	3066	50	13,20
LSZ12.637.0100	12,0	6x37	7530	3066	100	12,96
LSZ12.637.0200	12,0	6x37	7530	3066	200	12,70
LSZ12.637.0500	12,0	6x37	7530	3066	500	15,78
LSZ12.637.1000	12,0	6x37	7530	3066	1000	17,32
LSZ13.637.0050	13,0	6x37	8830	3066	50	17,20
LSZ14.637.0050	14,0	6x37	10220	3066	50	22,16
LSZ14.637.0100	14,0	6x37	10220	3066	100	21,78
LSZ16.637.0050	16,0	6x37	13400	3066	50	21,60
LSZ16.637.0100	16,0	6x37	13400	3066	100	21,20
LSZ16.637.0500	16,0	6x37	13400	3066	500	20,06
LSZ18.637.0050	18,0	6x37	17000	3066	50	34,54
LSZ18.637.0100	18,0	6x37	17000	3066	100	34,40
LSZ20.637.0050	20,0	6x37	20900	3066	50	33,32
LSZ20.637.0100	20,0	6x37	20900	3066	100	32,62
LSZ20.637.0500	20,0	6x37	20900	3066	500	32,05

## Lina stalowa w powłoce PCV

Steel wire ropes, galvanized, PVC coated



INDEX	ŚREDNICA ZEWNIĘTRZNA DIAMETER [mm]	ŚR. LINY STALOWEJ DIAMETER OF THE STEEL ROPE [mm]	KONSTRUKCJA TYPE	SIŁA ZRYWAJĄCA BREAKING FORCE [kg]	ILOŚĆ QUANTITY [mb]	CENA / PRICE 1 mb [PLN]
LPS-02	2,0	1,0	1 x 7	95	500	0,38
LPS-03	3,0	2,0	6 x 7	230	250	0,62
LPS-04	4,0	3,0	6 x 7	539	200	0,96
LPS-052	5,0	2,5	6 x 7	367	150	1,56
LPS-054	5,0	4,0	6 x 7	958	150	1,96
LPS-063	6,0	3,0	6 x 7	529	100	2,08
LPS-065	6,0	5,0	6 x 7	958	100	2,80
LPS-08	8,0	6,0	6 x 7	2100	50	4,40
LPS-10	10,0	8,0	6 x 19	3480	50	7,30

## Lina stalowa z pętelkami

Steel wire rope with loops

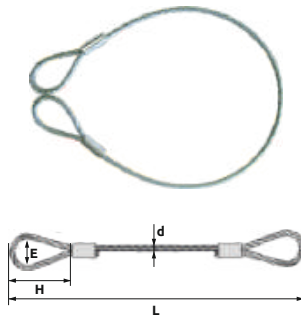

INDEX	ŚREDNICA DIAMETER d [mm]	L [m]	E [mm]	H [mm]	ILOŚĆ QUANTITY [mb]	CENA / PRICE 1 szt./pcs [PLN]
LSZP-0803	8,0	3	35	80	1	19,38
LSZP-0805	8,0	5	35	80	1	22,92
LSZP-1003	10,0	3	45	100	1	47,57
LSZP-1005	10,0	5	45	100	1	63,43
LSZP-1203	12,0	3	47	120	1	49,16
LSZP-1205	12,0	5	47	120	1	82,46
LSZP-1403	14,0	3	65	142	1	65,01
LSZP-1405	14,0	5	65	142	1	111,00
LSZP-1603	16,0	3	70	163	1	103,07
LSZP-1605	16,0	5	70	163	1	144,30
LSZP-1805	18,0	5	80	180	1	182,37
LSZP-2005	20,0	5	90	205	1	218,84

## Lina pleciona

Braided (polypropylene) twine



INDEX	ŚREDNICA DIAMETER [mm]	ILOŚĆ QUANTITY [mb]	CENA / PRICE 1 mb [PLN]
LP-02	2,0	600	0,18
LP-03	3,0	500	0,30
LP-04	4,0	400	0,36
LP-05	5,0	300	0,52
LP-06	6,0	300	0,79
LP-08	8,0	300	1,35
LP-10	10,0	200	1,72
LP-12	12,0	150	2,20
LP-14	14,0	100	3,05
LP-16	16,0	80	3,90
LP-18	18,0	60	4,90
LP-20	20,0	50	6,50
LP-24	24,0	20	10,33
LP-26	26,0	20	12,17
LP-28	28,0	20	15,75

## Lina elastyczna

Braided flexible twine



INDEX	ŚREDNICA DIAMETER [mm]	ILOŚĆ QUANTITY [mb]	CENA / PRICE 1 mb [PLN]
LPG-04	4,0	200	1,10
LPG-06	6,0	100	1,80
LPG-08	8,0	100	2,25
LPG-10	10,0	100	3,20
LPG-12	12,0	80	4,20

## Sznurek murarski

Mason twine



INDEX	ILOŚĆ QUANTITY [mb]	CENA / PRICE 1 mb [PLN]
SZM-50	50	5,20
SZM-100	100	9,20

## Lina jutowa

Jute twine



INDEX	ŚREDNICA DIAMETER [mm]	ILOŚĆ QUANTITY [mb]	CENA / PRICE 1 szt./pcs [PLN]
LJ-1050	10,0	50	60,53
LJ-1250	12,0	50	87,90
LJ-1450	14,0	50	115,00
LJ-1650	16,0	50	154,20
LJ-1850	18,0	50	167,00
LJ-2030	20,0	30	122,50
LJ-2050	20,0	50	174,00

## Błoczek budowlany Pulley



INDEX	ROZMIAR KOŁA SIZE [mm]	MAKS. ŚREDNICA LINY MAX ROPE DIAMETER [mm]	MAKS. OBCIĄŻENIE ROBOCZE MAX WORK LOAD [kg]	ILOŚĆ [szt.] QUANTITY [pcs]	CENA / PRICE 1 szt. / pcs [PLN]
<b>BLOB-100</b>	100	20	150	10	39,90
<b>BLOB-165</b>	165	22	200	10	49,30
<b>BLOB-200</b>	200	24	200	8	108,40
<b>BLOB-250</b>	250	26	250	4	132,00

## Błoczek budowlany pojedynczy Single pulley

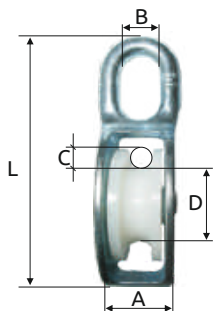

INDEX	A [mm]	B [mm]	D [mm]	C [mm]	L [mm]	ILOŚĆ [szt.] QUANTITY [pcs]	CENA / PRICE 1 szt. / pcs [PLN]
<b>BLO-1020</b>	18,0	10,0	11,0	5,0	60,0	100	3,24
<b>BLO-1025</b>	20,0	12,0	15,0	5,0	70,0	100	3,72
<b>BLO-1030</b>	22,0	13,0	18,0	6,0	80,0	10	5,30
<b>BLO-1040</b>	25,0	14,0	26,0	8,0	93,0	10	7,45
<b>BLO-1050</b>	29,0	16,0	31,0	10,0	112,0	10	10,99

## Błoczek budowlany podwójny Double pulley

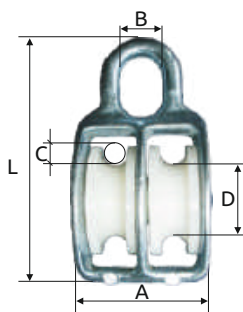

INDEX	A [mm]	B [mm]	D [mm]	C [mm]	L [mm]	ILOŚĆ [szt.] QUANTITY [pcs]	CENA / PRICE 1 szt. / pcs [PLN]
<b>BLO-2020</b>	30,0	10,0	11,0	5,0	60,0	50	4,90
<b>BLO-2025</b>	36,0	12,0	15,0	5,0	70,0	50	6,30
<b>BLO-2030</b>	42,0	13,0	18,0	6,0	80,0	50	8,30
<b>BLO-2040</b>	47,0	14,0	26,0	8,0	93,0	10	13,30
<b>BLO-2050</b>	52,0	16,0	31,0	10,0	112,0	10	18,90

## Kausza do lin stalowych, ocynkowana Wire rope thimble

DIN 6899 B

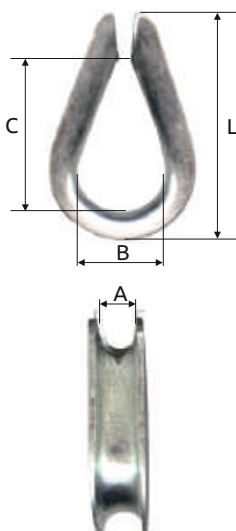

INDEX	A [mm]	L [mm]	B [mm]	C [mm]	ILOŚĆ [szt.] QUANTITY [pcs]	CENA / PRICE 1 szt. / pcs [PLN]
<b>KA-03</b>	3,0	22,0	12,0	19,0	100	0,33
<b>KA-04</b>	4,0	26,0	13,0	21,0	100	0,37
<b>KA-05</b>	5,0	32,0	14,0	23,0	100	0,42
<b>KA-06</b>	6,0	38,0	16,0	25,0	100	0,50
<b>KA-08</b>	8,0	51,0	20,0	32,0	50	0,77
<b>KA-10</b>	10,0	57,0	24,0	38,0	25	0,87
<b>KA-12</b>	12,0	64,0	28,0	45,0	25	1,34
<b>KA-14</b>	14,0	76,0	32,0	51,0	10	1,99
<b>KA-16</b>	16,0	83,0	36,0	58,0	10	2,48
<b>KA-18</b>	18,0	95,0	40,0	64,0	10	3,67
<b>KA-20</b>	20,0	102,0	45,0	72,0	10	4,74
<b>KA-22</b>	22,0	114,0	50,0	80,0	10	5,22
<b>KA-24</b>	24,0	127,0	56,0	90,0	10	7,77
<b>KA-26</b>	26,0	140,0	62,0	99,0	5	12,00
<b>KA-28</b>	28,0	152,0	70,0	112,0	5	14,30
<b>KA-30</b>	30,0	165,0	75,0	120,0	5	18,06

## Zacisk siodełkowy pojedynczy

Single clamp

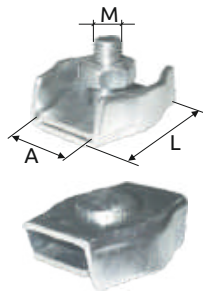

INDEX	M	A [mm]	L [mm]	ILOŚĆ [szt.] QUANTITY [pcs]	CENA / PRICE 1 szt. / pcs [PLN]
ZACS-02	M4	5,0	15,0	100	0,28
ZACS-03	M4	7,0	17,0	100	0,33
ZACS-04	M5	9,0	20,0	100	0,45
ZACS-05	M5	10,0	25,0	100	0,57
ZACS-06	M6	12,0	30,0	50	0,74
ZACS-08	M8	18,0	37,0	50	1,27

## Zacisk siodełkowy podwójny

Double clamp

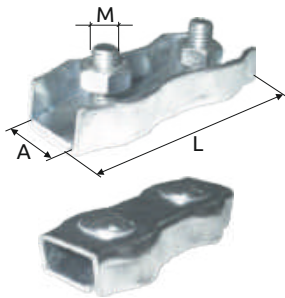

INDEX	M	A [mm]	L [mm]	ILOŚĆ [szt.] QUANTITY [pcs]	CENA / PRICE 1 szt. / pcs [PLN]
ZACSP-02	M4	5,0	30,0	100	0,45
ZACSP-03	M4	7,0	35,0	100	0,49
ZACSP-04	M5	9,0	40,0	100	0,81
ZACSP-05	M5	10,0	50,0	100	0,99
ZACSP-06	M6	12,0	60,0	25	1,30
ZACSP-08	M8	18,0	76,0	25	2,58

## Zacisk linowy kubekowy, ocynkowany

Egg shaped wire rope clip

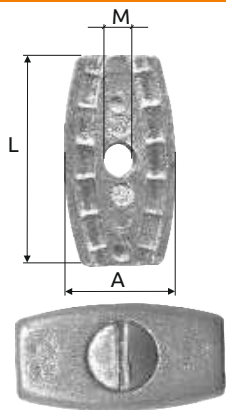

INDEX	M	A [mm]	L [mm]	ILOŚĆ [szt.] QUANTITY [pcs]	CENA / PRICE 1 szt. / pcs [PLN]
ZACK-02	M5	14,0	28,0	100	1,30
ZACK-03	M5	15,0	28,0	100	1,34
ZACK-04	M6	19,0	34,0	25	2,08
ZACK-05	M6	20,0	34,0	25	2,25
ZACK-06	M6	25,0	35,0	25	2,48

## Zacisk do lin, ocynkowany

Wire rope clip

DIN 741

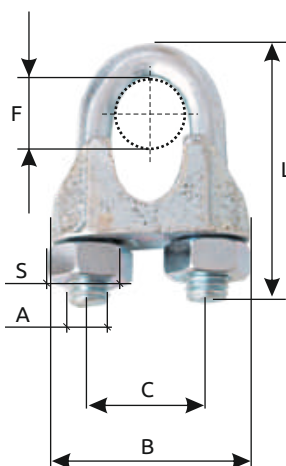

INDEX	F [mm]	L [mm]	B [mm]	A [mm]	C [mm]	S [mm]	ILOŚĆ [szt.] QUANTITY [pcs]	CENA / PRICE 1 szt. / pcs [PLN]
ZAC-03	3,0	16,0	21,0	4,0	9,0	7	100	0,21
ZAC-05	5,0	19,0	23,0	5,0	11,0	8	100	0,27
ZAC-06	6,0	23,0	26,0	5,0	13,0	8	50	0,32
ZAC-08	8,0	28,0	30,0	6,0	16,0	10	50	0,43
ZAC-10	10,0	35,0	34,0	8,0	19,0	13	25	0,80
ZAC-11	11,0	37,0	36,0	8,0	20,0	13	25	1,15
ZAC-12	12,0	45,0	42,0	10,0	24,0	17	10	1,50
ZAC-13	13,0	45,0	42,0	10,0	24,0	17	10	1,53
ZAC-14	14,0	46,0	44,0	10,0	25,0	17	10	1,58
ZAC-16	16,0	51,0	50,0	12,0	29,0	19	10	2,45
ZAC-19	19,0	62,0	54,0	12,0	32,0	19	10	2,98
ZAC-22	22,0	72,0	61,0	14,0	37,0	22	5	4,42
ZAC-24	24,0	75,0	63,0	14,0	39,0	22	5	4,93
ZAC-26	26,0	76,0	65,0	14,0	41,0	22	5	5,50
ZAC-30	30,0	95,0	74,0	16,0	48,0	24	5	7,83
ZAC-34	34,0	105,0	80,0	16,0	52,0	24	5	9,00
ZAC-40	40,0	125,0	88,0	16,0	58,0	24	5	10,83

## Szekla

JIS Type D shackle

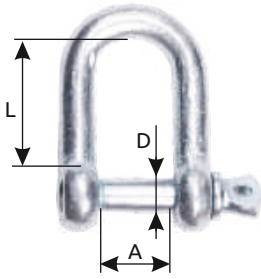

INDEX	D [mm]	A [mm]	L [mm]	ILOŚĆ [szt.] QUANTITY [pcs]	CENA / PRICE 1 szt. / pcs [PLN]
SZE-035	3,9	9,0	16,0	100	0,82
SZE-05	5,0	10,0	18,0	100	0,83
SZE-06	6,0	12,0	22,0	100	0,87
SZE-08	7,0	15,0	30,0	100	1,22
SZE-10	8,5	18,0	31,0	25	1,88
SZE-12	10,5	22,0	36,0	25	2,77
SZE-14	12,0	25,0	49,0	10	3,80
SZE-16	14,5	30,0	50,0	5	5,52
SZE-18	16,0	33,0	61,0	5	7,65
SZE-19/20	20,0	38,0	55,0	5	11,65
SZE-22	20,0	40,0	60,0	5	14,83
SZE-25	22,0	43,0	60,0	5	21,92
SZE-28	25,0	48,0	82,0	5	31,33
SZE-32	32,0	64,0	113,0	3	45,00
SZE-38	38,0	76,0	125,0	3	79,15
SZE-45	45,0	80,0	137,0	3	132,00

## Szekla specjalna

European type Dee shackle

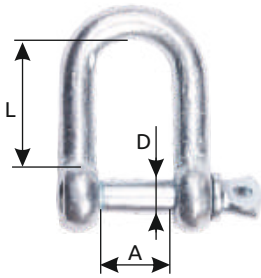

INDEX	D [mm]	A [mm]	L [mm]	ILOŚĆ [szt.] QUANTITY [pcs]	CENA / PRICE 1 szt. / pcs [PLN]
SZED-05	5,0	10,0	19,0	100	1,03
SZED-06	6,0	13,0	24,0	100	1,08
SZED-08	8,0	16,0	32,0	25	1,52
SZED-10	10,0	20,0	40,0	25	2,35
SZED-12	12,0	25,0	48,0	10	3,45
SZED-14	13,0	26,0	49,0	10	4,75
SZED-16	15,0	32,0	58,0	5	6,90
SZED-18	17,0	32,0	69,0	5	9,55
SZED-20	20,0	38,0	82,0	5	14,55
SZED-22	20,0	38,0	75,0	5	18,53
SZED-25	25,0	46,0	90,0	5	27,40

## Szekla Omega

Shackle bow / Omega type

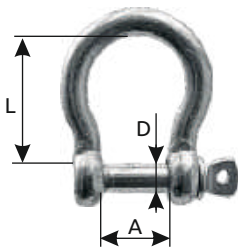

INDEX	D [mm]	A [mm]	L [mm]	ILOŚĆ [szt.] QUANTITY [pcs]	CENA / PRICE 1 szt. / pcs [PLN]
SZEO-035	4,0	8,0	16,0	100	0,89
SZEO-05	5,0	10,0	19,5	50	0,92
SZEO-06	6,0	13,5	26,0	50	1,19
SZEO-08	8,0	16,0	30,0	50	1,58
SZEO-10	10,0	19,0	36,0	10	2,50
SZEO-12	12,0	25,0	49,0	10	3,14
SZEO-14	13,0	28,0	52,0	10	4,90
SZEO-16	15,0	32,0	64,0	5	6,90
SZEO-18	17,0	30,0	71,0	5	10,94
SZEO-20	20,0	38,0	75,0	5	13,71

## Śruba rzymska - korpus

Turnbuckle

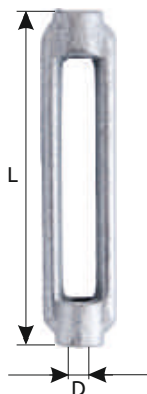

INDEX	D [mm]	L [mm]	ILOŚĆ [szt.] QUANTITY [pcs]	CENA / PRICE 1 szt. / pcs [PLN]
ŚRZK-06	6,0	88,0	50	1,80
ŚRZK-08	8,0	110,0	50	2,61
ŚRZK-10	10,0	130,0	25	3,28
ŚRZK-12	12,0	140,0	10	4,10
ŚRZK-14	14,0	170,0	10	7,20
ŚRZK-16	16,0	190,0	10	9,32
ŚRZK-18	18,0	200,0	5	10,92
ŚRZK-20	20,0	220,0	5	12,90
ŚRZK-24	24,0	255,0	5	22,50
ŚRZK-30	30,0	255,0	5	36,50
ŚRZK-32	32,0	255,0	5	43,80
ŚRZK-36	36,0	295,0	5	72,30

## Śruba rzymka hak - ucho

Turnbuckle hook-eye

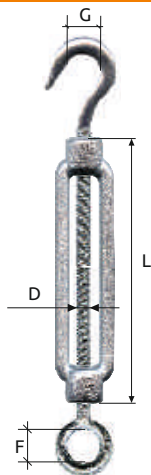

INDEX	D [mm]	L [mm]	G [mm]	F [mm]	ILOŚĆ [szt.] QUANTITY [pcs]	CENA / PRICE 1 szt. / pcs [PLN]
ŚRZ-05	5,0	79,0	6,0	8,0	25	1,75
ŚRZ-06	6,0	88,0	8,5	10,0	25	1,92
ŚRZ-08	8,0	110,0	10,0	11,0	10	2,48
ŚRZ-10	10,0	130,0	12,0	14,0	10	3,99
ŚRZ-12	12,0	140,0	16,0	17,0	5	6,76
ŚRZ-14	14,0	170,0	16,0	18,0	5	10,10
ŚRZ-16	16,0	190,0	16,5	23,0	5	14,25
ŚRZ-18	18,0	200,0	17,0	25,0	5	21,75
ŚRZ-20	20,0	220,0	17,5	25,0	5	27,60
ŚRZ-24	24,0	255,0	23,0	34,0	5	50,94
ŚRZ-30	30,0	255,0	29,0	38,0	5	99,51
ŚRZ-32	32,0	255,0	29,0	39,0	5	115,00

## Śruba rzymka hak - hak

Turnbuckle hook-hook

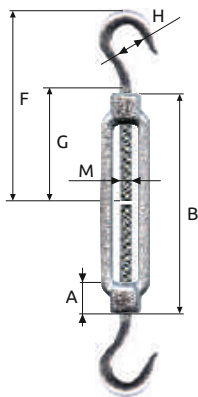

INDEX	M [mm]	A [mm]	B [mm]	F [mm]	G [mm]	H [mm]	ILOŚĆ [szt.] QUANTITY [pcs]	CENA / PRICE 1 szt. / pcs [PLN]
ŚRZH-05	5,0	9,0	79,0	62,0	40,0	6,0	25	1,75
ŚRZH-06	6,0	10,0	88,0	76,0	50,0	8,5	25	1,92
ŚRZH-08	8,0	12,0	110,0	89,0	52,0	10,0	10	2,48
ŚRZH-10	10,0	15,0	130,0	103,0	62,0	12,0	10	3,99
ŚRZH-12	12,0	18,0	140,0	121,0	65,0	16,0	5	6,76
ŚRZH-14	14,0	20,0	170,0	144,0	82,0	16,0	5	10,10
ŚRZH-16	16,0	22,5	190,0	172,0	105,0	16,5	5	14,25
ŚRZH-20	20,0	30,0	220,0	185,0	110,0	17,5	5	27,60
ŚRZH-24	24,0	39,0	255,0	225,0	135,0	23,0	5	50,94
ŚRZH-32	34,0	45,0	255,0	250,0	145,0	29,0	5	115,00

## Śruba rzymka ucho - ucho

Turnbuckle eye-eye

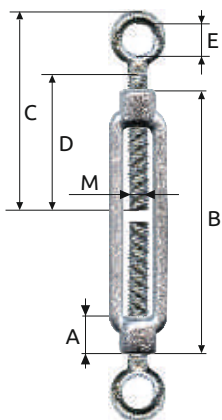

INDEX	M [mm]	A [mm]	B [mm]	C [mm]	D [mm]	E [mm]	ILOŚĆ [szt.] QUANTITY [pcs]	CENA / PRICE 1 szt. / pcs [PLN]
ŚRZU-05	5,0	9,0	79,0	59,0	40,0	8,0	25	1,75
ŚRZU-06	6,0	10,0	88,0	74,0	50,0	10,0	25	1,92
ŚRZU-08	8,0	12,0	110,0	80,0	52,0	11,0	10	2,48
ŚRZU-10	10,0	15,0	130,0	97,0	60,0	14,0	10	3,99
ŚRZU-12	12,0	18,0	140,0	106,0	67,0	17,0	5	6,76
ŚRZU-14	14,0	20,0	170,0	126,0	83,0	18,0	5	10,10
ŚRZU-16	16,0	22,5	190,0	160,0	97,0	23,0	5	14,25
ŚRZU-18	18,0	27,0	200,0	178,0	112,0	25,0	5	21,75
ŚRZU-20	20,0	30,0	220,0	190,0	116,0	25,0	5	27,60
ŚRZU-24	24,0	39,0	255,0	210,0	125,0	34,0	5	50,94
ŚRZU-32	32,0	45,0	255,0	242,0	150,0	39,0	5	115,00
ŚRZU-42	42,0	63,0	300,0	320,0	180,0	55,0	5	411,00

## Śruba rzymka prosta

Turnbuckle straight ends

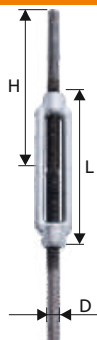

INDEX	D [mm]	L [mm]	H [mm]	ILOŚĆ [szt.] QUANTITY [pcs]	CENA / PRICE 1 szt. / pcs [PLN]
ŚRZP-08	8,0	110,0	120,0	25	3,88
ŚRZP-10	10,0	130,0	150,0	25	4,76
ŚRZP-12	12,0	140,0	150,0	10	7,49
ŚRZP-14	14,0	170,0	180,0	10	11,90
ŚRZP-16	16,0	190,0	200,0	5	16,20
ŚRZP-20	20,0	220,0	220,0	5	29,90
ŚRZP-24	24,0	255,0	260,0	5	42,80
ŚRZP-30	30,0	255,0	260,0	5	70,00

**Śruba rzymska hak - ucho**  
 Turnbuckle hook-eye

DIN 1480

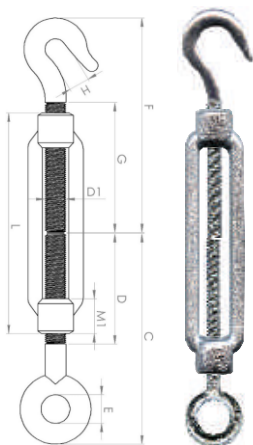

INDEX	D1 [mm]	M1 [mm]	L [mm]	C [mm]	D [mm]	E [mm]	F [mm]	G [mm]	H [mm]	ILOŚĆ [szt.] QUANTITY [pcs]	CENA / PRICE 1 szt. / pcs [PLN]
ŚRZD-05	M5	9	70	52	33	8	56	33	7,0	50	2,97
ŚRZD-06	M6	12	110	74	50	10	76	50	8,5	25	4,11
ŚRZD-08	M8	15	110	80	52	11	89	52	10,0	25	5,10
ŚRZD-10	M10	18	125	97	60	14	103	62	12,0	10	7,49
ŚRZD-12	M12	21	125	106	67	17	121	65	16,0	10	10,70
ŚRZD-14	M14	23	140	126	83	18	144	82	16,0	5	14,30
ŚRZD-16	M16	27	170	160	97	23	172	105	16,5	5	19,73
ŚRZD-18	M18	32	200	165	110	23	200	110	18,0	5	35,73
ŚRZD-20	M20	34	200	190	116	25	185	110	17,5	5	39,70
ŚRZD-24	M24	39	255	210	125	34	225	135	23,0	5	63,67
ŚRZD-30	M30	45	255	240	150	38	250	145	29,0	5	103,00

**Śruba rzymska hak - hak**  
 Turnbuckle hook-hook

DIN 1480

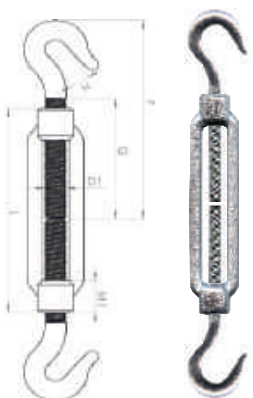

INDEX	D1 [mm]	M1 [mm]	L [mm]	F [mm]	G [mm]	H [mm]	ILOŚĆ [szt.] QUANTITY [pcs]	CENA / PRICE 1 szt. / pcs [PLN]
SRZDHH05	M5	9	70	56	33	7,0	50	2,97
SRZDHH06	M6	12	110	76	50	8,5	25	4,11
SRZDHH08	M8	15	110	89	52	10,0	25	5,10
SRZDHH10	M10	18	125	103	62	12,0	10	7,49
SRZDHH12	M12	21	125	121	65	16,0	10	10,70
SRZDHH14	M14	23	140	144	82	16,0	5	14,30
SRZDHH16	M16	27	170	172	105	16,5	5	19,73
SRZDHH18	M18	32	200	200	110	18,0	5	35,73
SRZDHH20	M20	34	200	185	110	17,5	5	39,70
SRZDHH24	M24	39	255	225	135	23,0	5	63,67
SRZDHH30	M30	45	255	250	145	29,0	5	103,00

**Śruba rzymska ucho - ucho**  
 Turnbuckle eye-eye

DIN 1480

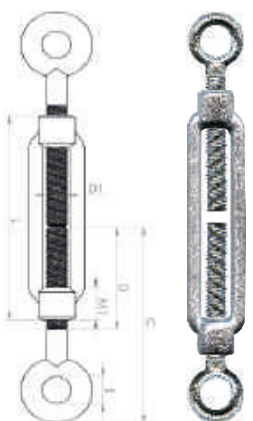

INDEX	D1 [mm]	M1 [mm]	L [mm]	C [mm]	D [mm]	E [mm]	ILOŚĆ [szt.] QUANTITY [pcs]	CENA / PRICE 1 szt. / pcs [PLN]
SRZDUU05	M5	9	70	52	33	8	50	2,97
SRZDUU06	M6	12	110	74	50	10	25	4,11
SRZDUU08	M8	15	110	80	52	11	25	5,10
SRZDUU10	M10	18	125	97	60	14	10	7,49
SRZDUU12	M12	21	125	106	67	17	10	10,70
SRZDUU14	M14	23	140	126	83	18	5	14,30
SRZDUU16	M16	27	170	160	97	23	5	19,73
SRZDUU18	M18	32	200	165	110	23	5	35,73
SRZDUU20	M20	34	200	190	116	25	5	39,70
SRZDUU24	M24	39	255	210	125	34	5	63,67
SRZDUU30	M30	45	255	240	150	38	5	103,00

## Hak huštawkowy z karabińczykiem

Swing hook with carabiner



INDEX	ROZMIAR SIZE [mm]	ILOŚĆ [szt.] QUANTITY [pcs]	CENA / PRICE 1 szt. / pcs [PLN]
HHK10140	M10 x 140	20	9,00

## Hak huštawkowy z szklą

Swing hook with a shackle



INDEX	ROZMIAR SIZE [mm]	ILOŚĆ [szt.] QUANTITY [pcs]	CENA / PRICE 1 szt. / pcs [PLN]
HHS10200	M10 x 200	20	10,00
HHS12200	M12 x 200	20	14,00

## Hak zwykły

Hook

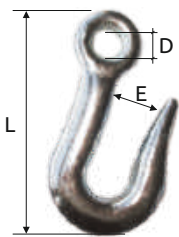

INDEX	D [mm]	E [mm]	L [mm]	ILOŚĆ [szt.] QUANTITY [pcs]	CENA / PRICE 1 szt. / pcs [PLN]
HAK-05	8,5	13,0	56,0	25	1,52
HAK-06	9,0	15,0	68,0	10	1,85
HAK-07	10,0	16,0	80,0	10	2,73
HAK-08	11,0	17,0	89,0	10	3,39
HAK-09	12,0	18,0	100,0	10	4,92
HAK-10	12,5	18,0	113,0	5	6,81
HAK-12	15,0	20,0	118,0	5	8,23

## Hak z zabezpieczeniem i uchem, ocynkowany lub lakierowany

Hook with latch

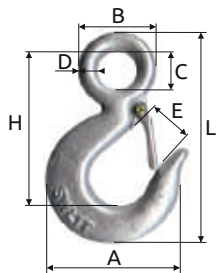

INDEX	UDŹWIG CAPACITY [kg]	A [mm]	B [mm]	C [mm]	D [mm]	E [mm]	H [mm]	L [mm]	ILOŚĆ [szt.] QUANTITY [pcs]	CENA / PRICE 1 szt. / pcs [PLN]
HAKU-0750	750	67	38	19,5	9,25	25	81,0	110	5	7,50
HAKU-1000	1000	77	45	22,0	11,50	26	93,0	125	5	10,10
HAKU-1500	1500	86	52	28,0	12,00	28	103,0	140	5	14,30
HAKU-2000	2000	97	62	31,0	15,50	31	119,0	163	5	19,12
HAKU-3000	3000	123	74	39,0	17,50	39	147,0	201	5	34,00
HAKU-5000	5000	149	95	51,0	22,00	47	185,5	255	5	69,00

## Hak sworzniowy, ocynkowany

Heavy-duty hook

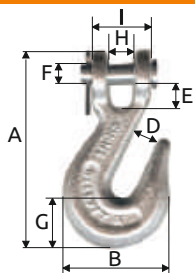

INDEX	UDŹWIG CAPACITY [kg]	A [mm]	B [mm]	D [mm]	E [mm]	F [mm]	G [mm]	H [mm]	I [mm]	ILOŚĆ [szt.] QUANTITY [pcs]	CENA / PRICE 1 szt. / pcs [PLN]
HAKS-014	1180	78	47	9,0	8,5	9,3	19,0	8,0	26	10	6,71
HAKS-516	1770	96	54	11,5	10,5	10,2	25,0	11,0	30	10	10,16
HAKS-038	2450	114	65	12,5	13,0	11,5	30,5	12,5	37	10	12,33

## Hak z zabezpieczeniem, ocynkowany lub lakierowany

Hook with latch

DIN 689

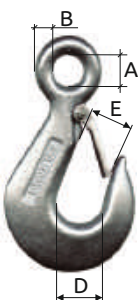

INDEX	UDŹWIG CAPACITY [kg]	A [mm]	B [mm]	D [mm]	E [mm]	ILOŚĆ [szt.] QUANTITY [pcs]	CENA / PRICE 1 szt. / pcs [PLN]
HAKZ-0250	250	9,5	7,5	23,0	18,0	10	4,41
HAKZ-0500	500	12,5	10,0	31,0	24,0	5	7,95
HAKZ-1000	1000	18,0	13,0	42,0	33,0	5	19,45
HAKZ-1600	1600	24,0	16,0	50,0	39,0	5	30,43
HAKZ-2500	2500	25,0	20,0	58,0	49,0	5	56,60

## Hak obrotowy z zabezpieczeniem - ocynkowany lub lakierowany

Painted swivel hook with latch

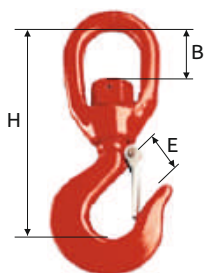

INDEX	UDŹWIG CAPACITY [kg]	B [mm]	E [mm]	H [mm]	ILOŚĆ [szt.] QUANTITY [pcs]	CENA / PRICE 1 szt. / pcs [PLN]
HAKO-0750	750	24,0	22,0	114,0	5	16,50
HAKO-1000	1000	33,0	24,0	135,0	5	19,20
HAKO-1500	1500	41,0	25,0	153,0	5	27,45
HAKO-2000	2000	43,0	28,0	162,0	5	36,60
HAKO-3000	3000	45,0	34,0	188,0	5	84,00
HAKO-5000	5000	64,0	42,0	245,0	5	131,00

## Ogniwo typ S - ocynkowane

Quick link type S (S light hook)

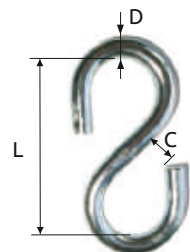

INDEX	D [mm]	L [mm]	C [mm]	ILOŚĆ [szt.] QUANTITY [pcs]	CENA / PRICE 1 szt. / pcs [PLN]
OGN-03	3,0	28,0	3,5	100	0,16
OGN-04	4,0	32,0	4,0	100	0,25
OGN-05	5,0	38,0	6,0	100	0,44
OGN-06	6,0	50,0	7,0	100	0,65
OGN-07	7,0	55,0	8,0	50	0,92
OGN-08	8,0	60,0	10,0	50	1,35

## Ogniwo zaklepywane - ocynkowane

Repair link

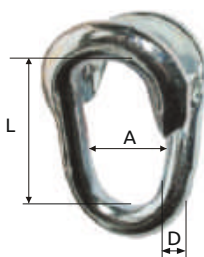

INDEX	D [mm]	L [mm]	A [mm]	ILOŚĆ [szt.] QUANTITY [pcs]	CENA / PRICE 1 szt. / pcs [PLN]
OGZ-04	4,0	24,0	7,5	100	0,38
OGZ-05	5,0	28,0	9,5	100	0,60
OGZ-06	6,0	33,0	12,0	50	0,79
OGZ-07	7,0	36,0	14,0	50	1,15
OGZ-08	8,0	40,0	17,0	25	1,85
OGZ-10	10,0	52,0	22,0	25	3,20

## Ogniwo skręcane - ocynkowane

Quick link

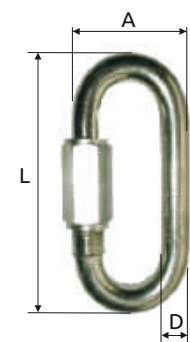

INDEX	D [mm]	L [mm]	A [mm]	ILOŚĆ [szt.] QUANTITY [pcs]	CENA / PRICE 1 szt. / pcs [PLN]
OGS-04	4,0	43,0	19,0	100	0,73
OGS-05	5,0	50,0	22,0	100	0,95
OGS-06	6,0	59,0	26,0	100	1,17
OGS-07	7,0	67,0	30,0	50	1,74
OGS-08	8,0	74,0	34,0	10	1,98
OGS-10	10,0	90,0	40,0	10	3,41
OGS-12	12,0	110,0	49,0	10	5,50
OGS-14	14,0	123,0	54,0	5	12,08
OGS-16	16,0	141,0	62,0	5	19,50

## Kółko zgrzewane - ocynkowane

Steel welded ring



INDEX	D [mm]	D <sub>1</sub> [mm]	ILOŚĆ [szt.] QUANTITY [pcs]	CENA / PRICE 1 szt. / pcs [PLN]
KZ-325	3	25	50	0,64
KZ-330	3	30	50	0,67
KZ-425	4	25	50	0,72
KZ-430	4	30	50	0,78
KZ-525	5	25	50	0,86
KZ-530	5	30	50	0,89
KZ-535	5	35	50	0,97
KZ-635	6	35	50	1,17
KZ-645	6	45	50	1,31
KZ-735	7	35	50	1,53
KZ-835	8	35	50	1,75
KZ-845	8	45	50	1,92

## Śruba z uchem

Eye screw

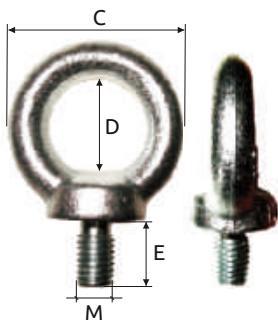

INDEX	M	C [mm]	D [mm]	E [mm]	ILOŚĆ [szt.] QUANTITY [pcs]	CENA / PRICE 1 szt. / pcs [PLN]
ŚRU-06	M6	26,0	16,0	14,0	50	1,40
ŚRU-08	M8	32,6	20,0	15,0	50	1,53
ŚRU-10	M10	41,0	25,0	18,0	10	2,40
ŚRU-12	M12	50,0	30,0	22,0	10	3,30
ŚRU-14	M14	50,0	30,0	22,0	5	4,53
ŚRU-16	M16	60,0	35,0	27,0	5	5,55
ŚRU-20	M20	72,0	40,0	30,0	5	7,65
ŚRU-24	M24	90,0	50,0	38,0	5	15,00
ŚRU-30	M30	110,0	60,0	45,0	5	36,00

## Nakrętka z uchem

Eye nut

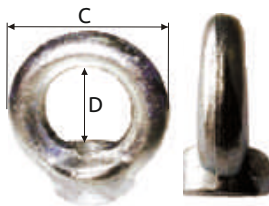

INDEX	M	C [mm]	D [mm]	ILOŚĆ [szt.] QUANTITY [pcs]	CENA / PRICE 1 szt. / pcs [PLN]
NAKU-06	M6	25,0	14,0	50	1,40
NAKU-08	M8	32,6	20,0	50	1,53
NAKU-10	M10	41,0	25,0	10	2,40
NAKU-12	M12	50,0	30,0	10	3,30
NAKU-14	M14	50,0	30,0	5	4,53
NAKU-16	M16	60,0	35,0	5	5,55
NAKU-20	M20	72,0	40,0	5	7,65
NAKU-24	M24	90,0	50,0	5	15,00
NAKU-30	M30	110,0	60,0	5	36,00

## Karabińczyk do lin - ocynkowany

Snap hook

DIN 5299 C

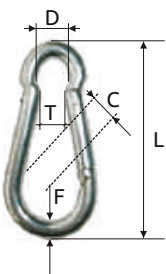

INDEX	F [mm]	L [mm]	T [mm]	D [mm]	C [mm]	ILOŚĆ [szt.] QUANTITY [pcs]	CENA / PRICE 1 szt. / pcs [PLN]
KAR-04	4,0	40,0	5,0	6,0	6,0	100	0,77
KAR-05	5,0	50,0	6,0	8,0	7,0	100	0,78
KAR-06	6,0	60,0	8,0	9,0	8,0	100	0,97
KAR-07	7,0	70,0	9,0	10,0	9,0	50	1,22
KAR-08	8,0	80,0	10,0	12,0	10,0	50	1,48
KAR-09	9,0	90,0	11,0	14,0	13,0	10	2,25
KAR-10	10,0	100,0	12,0	15,0	13,0	10	2,43
KAR-11	11,0	120,0	15,0	18,0	16,0	10	3,58
KAR-12	12,0	140,0	18,0	20,0	20,0	10	4,67
KAR-13	13,0	160,0	20,0	22,0	27,0	10	7,83

## Karabińczyk ozdobny - niklowany

Snap hook

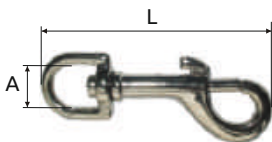

INDEX	L [mm]	A [mm]	ILOŚĆ [szt.] QUANTITY [pcs]	CENA / PRICE 1 szt. / pcs [PLN]
KAR-53	53,0	11,0	100	1,47
KAR-67	67,0	11,0	100	2,07
KAR-76	76,0	14,0	25	2,81

## Karabińczyk do lin z zabezpieczeniem - ocynkowany

Snap hook with safety screw

DIN 5299 D

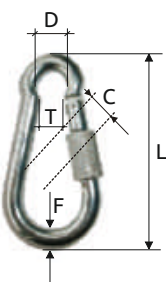

INDEX	F [mm]	L [mm]	T [mm]	D [mm]	C [mm]	ILOŚĆ [szt.] QUANTITY [pcs]	CENA / PRICE 1 szt. / pcs [PLN]
KARZ-04	4,0	40,0	5,0	6,0	6,0	100	1,05
KARZ-05	5,0	50,0	6,0	8,0	7,0	50	1,12
KARZ-06	6,0	60,0	8,0	9,0	8,0	50	1,20
KARZ-07	7,0	70,0	9,0	10,0	9,0	50	1,47
KARZ-08	8,0	80,0	10,0	11,0	10,0	50	1,74
KARZ-10	10,0	100,0	12,0	15,0	13,0	25	2,88
KARZ-11	11,0	120,0	15,0	18,0	16,0	10	3,91
KARZ-12	12,0	140,0	18,0	20,0	20,0	10	5,40
KARZ-13	13,0	160,0	20,0	22,0	27,0	10	9,20
KARZ-14	14,0	180,0	22,0	25,0	30,0	10	12,00

## Naciąg do siatki i drutu - ocynkowany lub zielony

Wire stretcher

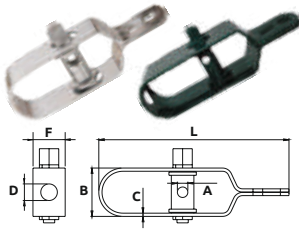

INDEX	KOLOR COLOR	L [mm]	B [mm]	C [mm]	A [mm]	D [mm]	F [mm]	ILOŚĆ [szt.] QUANTITY [pcs]	CENA / PRICE 1 szt. / pcs [PLN]
NAC-100o	L-100 ocynk/zinc	100	30	1,5	7,5	11	20	200	1,75
NAC-100z	L-100 zielony/green	100	30	1,5	7,5	11	20	200	2,22
NAC-120o	L-120 ocynk	120	30	2,0	11,0	14	20	100	2,25
NAC-120z	L-120 zielony	120	30	2,0	11,0	14	20	100	2,58

## Śruba naciągowa

Wire stretcher

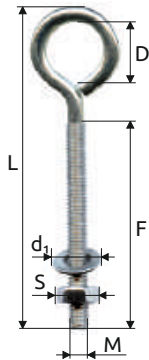

INDEX	ROZMIAR SIZE [mm]	S [mm]	d <sub>1</sub> [mm]	M [mm]	F [mm]	D [mm]	L [mm]	ILOŚĆ [szt.] QUANTITY [pcs]	CENA / PRICE 1 szt. / pcs [PLN]
NAC-06150	M6 x 150	10	12	6	150	10,0	173	50	1,22
NAC-08100	M8 x 100	13	16	8	100	15,5	130	50	1,40
NAC-08150	M8 x 150	13	16	8	150	15,5	183	50	2,00
NAC-08160	M8 x 160	13	16	8	160	15,5	194	50	2,20
NAC-08180	M8 x 180	13	16	8	180	15,5	214	50	2,50
NAC-08200	M8 x 200	13	16	8	200	15,5	233	50	2,80
NAC-10120	M10 x 120	17	20	10	120	20,5	164	50	2,60
NAC-10150	M10 x 150	17	20	10	150	20,5	193	50	3,25
NAC-10180	M10 x 180	17	20	10	180	20,5	222	25	3,80
NAC-10200	M10 x 200	17	20	10	200	20,5	242	25	4,45

## Zawlecza rolnicza - ocynk żółty

Linch pin

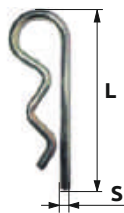

INDEX	S [mm]	L [mm]	ILOŚĆ [szt.] QUANTITY [pcs]	CENA / PRICE 1 szt. / pcs [PLN]
ZAW-02	2,0	50,0	25 / 5000	0,26
ZAW-03	3,0	70,0	25 / 1500	0,30
ZAW-04	4,0	80,0	25 / 1000	0,45
ZAW-05	5,0	100,0	25 / 500	0,60
ZAW-06	6,0	110,0	25 / 250	1,10

## Zawlecza - przetyczka rolnicza

Spring pin

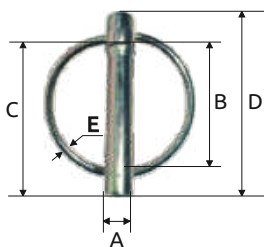

INDEX	A [mm]	C [mm]	B [mm]	E [mm]	D [mm]	ILOŚĆ [szt.] QUANTITY [pcs]	CENA / PRICE 1 szt. / pcs [PLN]
ZAB-04	4,0	30,0	27,0	2,6	37	25 / 1500	0,64
ZAB-05	5,0	45,0	36,5	3,0	52	25 / 1000	0,76
ZAB-06	6,0	45,0	36,5	3,2	54	25 / 800	0,92
ZAB-07	7,0	45,0	36,5	3,3	55	25 / 500	1,04
ZAB-08	8,0	45,0	36,5	3,3	55	25 / 500	1,18
ZAB-09	9,0	45,0	36,5	3,5	56	25 / 500	1,44
ZAB-10	10,0	45,0	36,5	3,5	56	25 / 250	1,76
ZAB-11	11,0	45,0	36,5	3,5	56	25 / 250	1,92

## Zawlecza rozginana

Split pin

DIN94 / PN82001

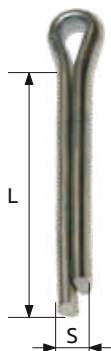

INDEX	S [mm]	L [mm]	CENA / PRICE 1 kg [PLN]	INDEX	S [mm]	L [mm]	CENA / PRICE 1 kg [PLN]
ZAR-02020	2,0	20	33,04	ZAR-05032	5,0	32	14,15
ZAR-02025	2,0	25	33,04	ZAR-05045	5,0	45	14,15
ZAR-02036	2,0	36	33,04	ZAR-05050	5,0	50	14,15
ZAR-02520	2,5	20	30,82	ZAR-05080	5,0	80	14,15
ZAR-02525	2,5	25	30,82	ZAR-06332	6,3	32	13,92
ZAR-02536	2,5	36	30,82	ZAR-06345	6,3	45	13,92
ZAR-03225	3,2	25	16,40	ZAR-06363	6,3	63	13,92
ZAR-03228	3,2	28	16,40	ZAR-06371	6,3	71	13,92
ZAR-03240	3,2	40	16,40	ZAR-063100	6,3	100	13,92
ZAR-03245	3,2	45	16,40	ZAR-08056	8,0	56	13,70
ZAR-04025	4,0	25	14,34	ZAR-08080	8,0	80	13,70
ZAR-04032	4,0	32	14,34	ZAR-10071	10,0	71	13,47
ZAR-04045	4,0	45	14,34	ZAR-10100	10,0	100	13,47
ZAR-04050	4,0	50	14,34				

## Sprężyna (spinacz) do tańcucha

Swivel snap hook



INDEX	L [mm]	C [mm]	ILOŚĆ [szt.] QUANTITY [pcs]	CENA / PRICE 1 szt. / pcs [PLN]
SP-030	30,0	7,0	100	0,22
SP-040	40,0	8,5	100	0,30
SP-050	50,0	10,5	100	0,42
SP-060	60,0	12,5	50	0,75
SP-070	70,0	14,0	50	0,89
SP-080	80,0	16,0	50	1,33
SP-090	90,0	17,0	50	2,10

## Sprężyna (spinacz) z okrętką do tańcucha

Swivel snap hook



INDEX	L [mm]	C [mm]	ILOŚĆ [szt.] QUANTITY [pcs]	CENA / PRICE 1 szt. / pcs [PLN]
SPO-030	30,0	7,0	100	0,45
SPO-040	40,0	8,5	100	0,65
SPO-050	50,0	10,5	100	1,11
SPO-060	60,0	12,5	50	1,34
SPO-070	70,0	14,0	50	1,56
SPO-080	80,0	16,0	50	2,32
SPO-090	90,0	17,0	50	2,97
SPO-100	100,0	18,0	50	4,42
SPO-120	120,0	19,0	25	5,47

## Krętek nikielowany

Swivel nickel plated

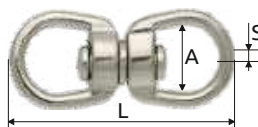

INDEX	L [mm]	A [mm]	S [mm]	ILOŚĆ [szt.] QUANTITY [pcs]	CENA / PRICE 1 szt. / pcs [PLN]
KREN-38	50,0	14,0	3,8	50	2,46
KREN-45	58,0	12,5	4,5	50	3,26
KREN-60	73,0	22,0	6,0	25	4,72

## Okrętka super

Swivel link

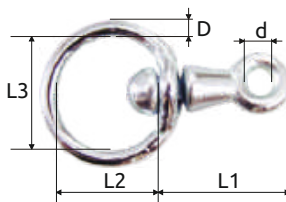

INDEX	D [mm]	L1 [mm]	L2 [mm]	L3 [mm]	d [mm]	ILOŚĆ [szt.] QUANTITY [pcs]	CENA / PRICE 1 szt. / pcs [PLN]
OKR-04	4,0	20,0	21,0	22,0	6,0	50	3,32
OKR-05	5,0	40,0	30,0	33,0	8,0	50	3,55
OKR-06	6,0	43,0	35,0	36,0	9,0	25	4,17
OKR-07	7,0	50,0	37,0	38,0	9,0	25	5,40
OKR-08	8,0	56,0	41,0	43,0	10,0	10	6,14
OKR-09	9,0	56,0	41,0	43,0	10,0	10	8,00
OKR-10	10,0	60,0	47,0	48,0	12,0	10	9,07

## Tuleja aluminiowa typ A

Aluminum sleeve

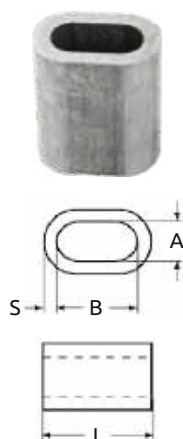

INDEX	A [mm]	B [mm]	S [mm]	L [mm]	ILOŚĆ [szt.] QUANTITY [pcs]	CENA / PRICE 1 szt. / pcs [PLN]
T-TA-01	1,4	2,5	0,70	5,0	100	0,14
T-TA-015	1,7	3,4	1,00	6,1	100	0,15
T-TA-02	2,2	4,4	1,00	7,0	100	0,17
T-TA-03	3,3	6,6	1,25	11,0	100	0,25
T-TA-04	4,4	8,8	1,70	14,0	100	0,33
T-TA-05	5,5	11,0	2,10	18,0	100	0,44
T-TA-06	6,6	13,2	2,50	21,0	100	0,53
T-TA-08	8,8	17,6	3,30	28,0	100	0,99
T-TA-10	10,9	21,8	4,10	35,0	100	1,67
T-TA-12	13,2	26,4	4,90	42,0	100	2,86
T-TA-13	14,2	28,4	5,40	46,0	100	3,75
T-TA-14	15,3	30,6	5,80	49,0	100	4,76
T-TA-16	17,5	35,0	6,70	56,0	100	6,82
T-TA-18	19,6	39,2	7,60	63,0	100	10,33

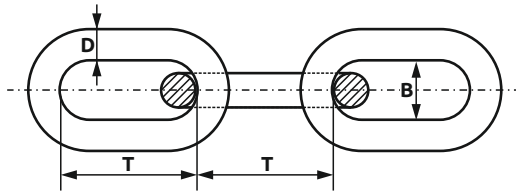

## Łańcuch techniczny, ocynkowany, na rolce

Technical steel chain

DIN 5685 A



INDEX	D [mm]	T [mm]	B <sub>MIN</sub> [mm]	ILOŚĆ [mb] QUANTITY [mb]	CENA / PRICE 1 mb [PLN]
ŁA-015	1,5	12,5	2,8	150	1,62
ŁA-020	2,0	12,0	3,6	150	2,02
ŁA-030	3,0	16,0	5,4	100	2,98
ŁA-040	4,0	19,0	7,2	52	5,23
ŁA-050	5,0	21,0	9,0	38	7,12
ŁA-060	6,0	24,0	10,8	36	10,05
ŁA-070	7,0	28,0	12,6	25	13,36
ŁA-080	8,0	32,0	14,4	22	15,26
ŁA-100	10,0	40,0	18,0	10	28,13

## Łańcuch gospodarczy „D-1”, ocynkowany, na rolce (krótkie ogniwo)

Steel chain type D1

DIN 5685 A



INDEX	D [mm]	T [mm]	B <sub>MIN</sub> [mm]	ORIENTACYJNA SIŁA ZRYWAJĄCA BREAKING FORCE [KGS]	ILOŚĆ [mb] QUANTITY [mb]	CENA / PRICE 1 mb [PLN]
ŁAG-015	1,5	12,5	2,8	40	150	1,42
ŁAG-02	2,0	12,0	3,6	125	110	1,38
ŁAG-03	3,0	16,0	5,4	280	60	1,90
ŁAG-04	4,0	19,0	7,2	500	40	3,02
ŁAG-05	5,0	21,0	9,0	775	30	4,82
ŁAG-06	6,0	24,0	10,8	1150	18	6,90
ŁAG-07	7,0	28,0	12,6	1500	16	9,25
ŁAG-08	8,0	32,0	14,4	2000	10	12,33
ŁAG-10	10,0	40,0	18,0	3100	10	18,51
ŁAG-12	12,0	48,0	21,6	4500	8	28,66

## Łańcuch gospodarczy „D-2”, ocynkowany, na rolce (długie ogniwo)

Steel chain type D2

DIN 5685 C



INDEX	D [mm]	T [mm]	B <sub>MIN</sub> [mm]	ORIENTACYJNA SIŁA ZRYWAJĄCA BREAKING FORCE [KGS]	ILOŚĆ [mb] QUANTITY [mb]	CENA / PRICE 1 mb [PLN]
ŁAGD-02	2,0	22,0	3,5	125	80	1,27
ŁAGD-03	3,0	26,0	5,0	280	60	1,74
ŁAGD-04	4,0	32,0	7,0	500	40	2,77
ŁAGD-05	5,0	35,0	9,0	775	30	4,20
ŁAGD-06	6,0	42,0	11,0	1150	18	6,48
ŁAGD-08	8,0	52,0	14,0	2000	10	11,50

## Łańcuch gospodarczy „D-1”, ocynkowany ogniwo, na rolce (krótkie ogniwo)

Hot Dip Galvanized Chain

DIN 5685 A



INDEX	D [mm]	T [mm]	B <sub>MIN</sub> [mm]	ORIENTACYJNA SIŁA ZRYWAJĄCA BREAKING FORCE [KGS]	ILOŚĆ [mb] QUANTITY [mb]	CENA / PRICE 1 mb [PLN]
ŁAGO-04	4,0	19,0	7,0	500	84	4,37
ŁAGO-05	5,0	21,0	9,0	775	56	7,00
ŁAGO-06	6,0	24,0	11,0	1150	36	10,20
ŁAGO-08	8,0	32,0	14,0	2000	22	16,57
ŁAGO-10	10,0	40,0	18,0	3100	14	23,20

## Łańcuch plastikowy

Plastic chain



INDEX	ROZMIAR SIZE [mm]	ILOŚĆ [mb] QUANTITY [mb]	CENA / PRICE 1 mb [PLN]
ŁAPL06BC	6,0	25	5,00
ŁAPL06ZC	6,0	25	5,00
ŁAPL08BC	8,0	25	6,70
ŁAPL08ZC	8,0	25	6,70

## Łańcuch węzłowy „Viktor” w wiązce lub na rolce VICTOR nodal chain

DIN 5686



INDEX	D [mm]	ILOŚĆ / QUANTITY [mb]		CENA / PRICE	
		WIAZKA BUNDLE	ROLKA ROLL	1 mb (bundle) [PLN]	1 mb (roll) [PLN]
ŁAV-14	1,4	30	150	1,00	1,08
ŁAV-16	1,6	30	130	1,03	1,10
ŁAV-18	1,8	30	130	1,18	1,26
ŁAV-20	2,0	30	118	1,44	1,54
ŁAV-22	2,2	30	118	1,62	1,74
ŁAV-25	2,5	30	70	1,90	2,05
ŁAV-28	2,8	30	66	2,18	2,33
ŁAV-30	3,0	30	40	2,36	2,54
ŁAV-38	3,8	30	-	3,08	-
ŁAV-46	4,6	30	30	5,90	6,34

## Łańcuszek niezgrzewany, ocynkowany Zinc-plated steel chain



INDEX	D [mm]	T [mm]	B <sub>MIN</sub> [mm]	ILOŚĆ W WIAZCE QUANTITY BUNDLE [mb]	CENA / PRICE 1 mb [PLN]
ŁAN-012	1,2	10,0	4,0	50	2,33
ŁAN-014	1,4	11,0	4,0	50	2,28
ŁAN-016	1,6	13,0	4,0	50	2,23
ŁAN-018	1,8	15,0	5,0	50	2,18
ŁAN-020	2,0	20,0	6,0	50	2,15
ŁAN-022	2,2	25,0	6,0	50	2,13
ŁAN-025	2,5	22,0	9,0	50	2,05

## Łańcuch spinający Spanning chain



INDEX	D [mm]	DŁUGOŚĆ LENGTH [cm]	Ø [mm]	ILOŚĆ W WIAZCE QUANTITY BUNDLE [mb]	CENA / PRICE 1 mb [PLN]
ŁASP-030	3,0	50	19	25	4,55
ŁASP-040	4,0	50	19	25	5,45
ŁASP-050	5,0	50	25	25	6,52

## Łańcuch dla psa Steel chain for dog



INDEX	D [mm]	DŁUGOŚĆ LENGTH [mb]	ILOŚĆ [szt.] QUANTITY [pcs]		CENA / PRICE 1 szt./ pcs [PLN]
ŁAP-020	2,0	3,0	1	50	7,58
ŁAP-025	2,5	3,0	1	40	8,06
ŁAP-030	3,0	3,0	1	40	8,83
ŁAP-040	4,0	3,0	1	25	13,67
ŁAP-050	5,0	3,0	1	20	18,94
ŁAP-060	6,0	3,0	1	10	25,61

## Łańcuch gospodarczy (pastwiskowy), ocynkowany Grazing steel chain



INDEX	D [mm]	DŁUGOŚĆ LENGTH [mb]	ILOŚĆ [szt.] QUANTITY [pcs]		CENA / PRICE 1 szt./ pcs [PLN]
ŁAPA-40	4,0	5,0	1	15	21,61
ŁAPA-50	5,0	5,0	1	10	27,00

## Łańcuch gospodarczy (żłobowy) Black manger chain

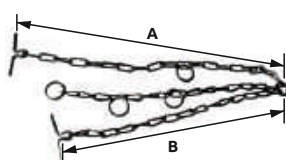

INDEX	D [mm]	A [mm]	B [mm]	ILOŚĆ [szt.] QUANTITY [pcs]		CENA / PRICE 1 szt./ pcs [PLN]
ŁAŻ-040	4,0	80	56	1	30	10,92
ŁAŻ-050	5,0	80	56	1	20	14,47
ŁAŻ-060	6,0	80	56	1	15	17,81
ŁAŻ-070	7,0	75	60	1	10	21,47
ŁAŻ-080	8,0	70	70	1	10	28,94

## Elektroda RC STANDARD / Welding electrode RC STANDARD



INDEX	ROZMIAR SIZE [mm]	WAGA WEIGHT [kg]	CENA / PRICE 1 kg [ PLN ]
EL-S25/350MON	2,5 x 350	2,5	9,92
EL-S32/350MON	3,2 x 350	2,5	9,46
EL-S40/450MON	4,0 x 450	5,0	9,35

## Elektroda RC INDUSTRY / Welding electrode RC INDUSTRY



INDEX	ROZMIAR SIZE [mm]	WAGA WEIGHT [kg]	CENA / PRICE 1 kg [ PLN ]
EL-I20/300MON	2,0 x 300	1,0	13,74
EL-I25/350MON	2,5 x 350	2,5	12,03
EL-I32/350MON	3,2 x 350	2,5	11,34
EL-I40/450MON	4,0 x 450	5,0	10,63

## Elektroda zasadowa PLASMA / Welding electrode PLASMA



INDEX	ROZMIAR SIZE [mm]	WAGA WEIGHT [kg]	CENA / PRICE 1 kg [ PLN ]
EL-Z25/350MON	2,5 x 350	2,5	10,74
EL-Z32/350MON	3,2 x 350	2,5	10,51

## Elektroda do INOX / Welding electrode INOX



INDEX	ROZMIAR SIZE [mm]	WAGA WEIGHT [kg]	CENA / PRICE 1 kg [ PLN ]
EL-IN25/350MON	2,5 x 350	1,0	42,03
EL-IN32/350MON	3,2 x 350	1,0	42,03



## Drut spawalniczy SG2 / Welding wire SG2



INDEX	RODZAJ TYPE	ŚREDNICA DIAMETER [mm]	WAGA WEIGHT [kg]	CENA / PRICE 1 kg [ PLN ]
DR-08/05Mon	G3Si1	0,8	5,0	9,78
DR-08/18Mon	G3Si1	0,8	18,0	9,42
DR-10/18Mon	G3Si1	1,0	18,0	9,14
DR-10/18MonSG3	G4Si1	1,0	18,0	9,12
DR-12/18Mon	G3Si1	1,2	18,0	8,77

## Elektroda ER 146 / Welding electrode ER 146



Średniootulona elektroda rutyłowa do spawania stali niskostopowych (niskowęglowych) we wszystkich zalecanych pozycjach. Zalecana do prac montażowych.

INDEX	ROZMIAR SIZE [mm]	WAGA WEIGHT [kg]	CENA / PRICE 1 kg [PLN]
<b>ELER-20300</b>	2,0 x 300	4,7	28,05
<b>ELER-25350</b>	2,5 x 350	5,0	18,22
<b>ELER-325450</b>	3,25 x 450	6,5	15,64
<b>ELER-40450</b>	4,0 x 450	6,5	15,36
<b>ELER-50450</b>	5,0 x 450	6,0	15,83

## Elektroda ER 150 / Welding electrode ER 150



Średniootulona elektroda rutyłowa do spawania stali niskostopowych (niskowęglowych) we wszystkich zalecanych pozycjach. Zalecana do prac montażowych.

INDEX	ROZMIAR SIZE [mm]	WAGA WEIGHT [kg]	CENA / PRICE 1 kg [PLN]
<b>ELEB-25350</b>	2,5 x 350	5,0	20,78
<b>ELEB-325350</b>	3,25 x 350	5,0	17,04
<b>ELEB-40350</b>	4,00 x 350	5,0	19,95

## Elektroda OVERCORD E / Welding electrode OVERCORD E



**OVERCORD E** jest elektrodą do spawania we wszystkich pozycjach, szczególnie z góry w dół. Zalecana do prac montażowych w przemyśle maszynowym i okrętowym. Przeznaczona do spawania stali niskowęglowych i niskostopowych.

INDEX	ROZMIAR SIZE [mm]	WAGA WEIGHT [kg]	CENA / PRICE 1 kg [PLN]
<b>ELO-20300</b>	2,0 x 300	1,9	35,96
<b>ELO-25350</b>	2,5 x 350	4,5	16,92
<b>ELO-325350</b>	3,25 x 350	4,5	15,21
<b>ELO-40350</b>	4,0 x 350	4,5	15,19

## Elektroda RUTILEN 12 350mm / Welding electrode RUTILEN 12



Uniwersalna elektroda do spawania konstrukcji stalowych szczególnie małogabarytowych i o cienkich ściankach. Polecana do spawania w pozycjach przymusowych w tym góra - dół. Stosowana w urządzeniach o niskim napięciu zajarzania u>50v.

INDEX	ROZMIAR SIZE [mm]	WAGA WEIGHT [kg]	CENA / PRICE 1 kg [PLN]
<b>ELR-12253501</b>	2,5 x 350	1,0	20,45
<b>ELR-12253505</b>	2,5 x 350	5,0	16,25
<b>ELR-123253501</b>	3,25 x 350	1,0	19,60
<b>ELR-123253505</b>	3,25 x 350	5,0	14,62
<b>ELR-12403501</b>	4,0 x 450	1,0	18,75
<b>ELR-12403505</b>	4,0 x 350	5,0	14,40
<b>ELR-12403505</b>	4,0 x 450	6,0	14,42

## Elektroda INOX 308L / Welding electrode INOX 308L



Elektroda grubo otulona rutyłowa INOX 308L do spawania stali nierdzewnych, kwasoodpornych i chromo - niklowych. Używana do spawania stali austenitycznej, odporna na korozję.

INDEX	ROZMIAR SIZE [mm]	WAGA WEIGHT [kg]	CENA / PRICE 1 kg [PLN]
<b>EL701-INOX</b>	2,0 x 300	1,3	94,20
<b>EL702-INOX</b>	2,5 x 300	1,4	77,00
<b>EL705-INOX</b>	3,25 x 350	1,7	75,00

## Drut spawalniczy EBD SG2 / Welding wire EBD SG2

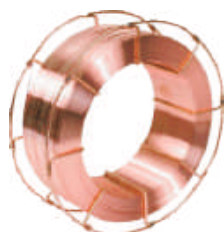

INDEX	RODZAJ TYPE	ŚREDNICA DIAMETER [mm]	WAGA WEIGHT [kg]	CENA / PRICE 1 kg [PLN]
<b>DRS0605</b>	TYS WELD	0,6	5,0	17,81
<b>DRS082</b>	TYS WELD	0,8	15,0	10,29
<b>DRS085</b>	TYS WELD	0,8	5,0	11,53
<b>DRS10</b>	TYS WELD	1,0	15,0	9,52
<b>DRS12</b>	TYS WELD	1,2	18,0	9,21
<b>DRS16</b>	TYS WELD	1,6	15,0	9,23

## Hak grzejnikowy, kątowy - stalowy, ocynkowany i lakierowany / Galvanized bent radiator hook



INDEX	RODZAJ TYPE	CENA / PRICE 1 szt./pcs [ PLN ]
HGK-01	ocynk / zinc	2,23
HGKM-01	lakierowany / lacquered	2,23

## Hak grzejnikowy - stalowy, ocynkowany i lakierowany / Galvanized radiator hook with long



INDEX	RODZAJ TYPE	CENA / PRICE 1 szt./pcs [ PLN ]
HG-01	ocynk / zinc	2,33
HGM-01	lakierowany / lacquered	2,33

Uchwyt do rur - stalowy, ocynkowany  
Pipe clamp

INDEX	ROZMIAR SIZE [cal]	ROZMIAR SIZE [mm]	CENA / PRICE 1 szt./pcs [ PLN ]
U-38	3/8	15-18	1,38
U-12	1/2	20-23	1,44
U-34	3/4	26-29	1,51
U-1	1	32-36	1,61
U-54	5/4	40-43	1,87
U-64	6/4	48-51	1,95
U-2	2	58-62	1,97
U-2 1/2	2 1/2	75-80	2,62
U-3	3	88-92	3,08
U-4	4	106-110	4,03
U-5	5	128-134	5,35
U-6	6	155-160	3,59
U-8	8	195-205	9,97

Uchwyt do rur z uszczelką gumową - stalowy, ocynk  
Pipe clamp with gasket

INDEX	ROZMIAR SIZE [cal]	ROZMIAR SIZE [mm]	CENA / PRICE 1 szt./pcs [ PLN ]
UT-38	3/8	15-18	1,64
UT-12	1/2	20-23	1,68
UT-34	3/4	26-29	1,73
UT-1	1	32-36	1,87
UT-54	5/4	40-43	2,13
UT-64	6/4	48-51	2,33
UT-2	2	58-62	2,62
UT-2 1/2	2 1/2	75-80	2,77
UT-3	3	88-92	3,05
UT-4	4	106-110	4,59
UT-5	5	128-134	5,82
UT-6	6	155-160	6,95
UT-8	8	195-205	12,46

Uchwyt do rur podwójny - stalowy, ocynkowany  
Double pipe clamp

INDEX	ROZMIAR SIZE [cal]	ROZMIAR SIZE [mm]	CENA / PRICE 1 szt./pcs [ PLN ]
UP-38	3/8	15-18	2,49
UP-12	1/2	20-23	2,74
UP-34	3/4	26-29	3,51
UP-1	1	32-36	4,20

Uchwyt do rur podwójny z uszczelką gumową - stalowy, ocynk  
Double pipe clamp with gasket

INDEX	ROZMIAR SIZE [cal]	ROZMIAR SIZE [mm]	CENA / PRICE 1 szt./pcs [ PLN ]
UPT-38	3/8	15-18	3,00
UPT-12	1/2	20-23	3,23
UPT-34	3/4	26-29	4,00
UPT-1	1	32-36	4,74

Uchwyt boczny do rur z uszczelką gumową - stalowy, ocynk  
Pipe clamp with gasket

INDEX	ROZMIAR SIZE [cal]	ROZMIAR SIZE [mm]	CENA / PRICE 1 szt./pcs [ PLN ]
UBT-38	3/8	15-18	2,08
UBT-12	1/2	20-23	2,15
UBT-34	3/4	26-29	2,44
UBT-1	1	32-36	2,70

Taśma SERRATUB W2 9mm  
Hose Clamp Roll

INDEX	RODZAJ TYPE	CENA / PRICE 1 szt./pcs [ PLN ]
TAŚ	Taśma W2 9mm / 30m	210,60
ZAMEK	Zamek do taśmy SERRATUB	3,74

## Opaska ślimakowa „K-2” GM (GERMAN MIDDLE) type hose clamp



OCYNKOWANA / ZINC			
INDEX	ZAKRES PRACY OPERATING RANGES [mm]	ILOŚĆ [szt.] QUANTITY [pcs]	CENA / PRICE 1 szt. / pcs [PLN]
OBI-00711	7-11	50	0,65
OBI-00812	8-12	50	0,65
OBI-01016	10-16	50	0,65
OBI-01222	12-22	50	0,68
OBI-01320	13-20	50	0,68
OBI-01627	16-27	50	0,68
OBI-02032	20-32	50	0,70
OBI-02540	25-40	50	0,77
OBI-03045	30-45	50	0,80
OBI-03850	38-50	50	0,81
OBI-04060	40-60	50	0,91
OBI-05070	50-70	50	0,94
OBI-06080	60-80	25	1,03
OBI-06885	68-85	25	1,03
OBI-080100	80-100	25	1,15
OBI-087112	87-112	25	1,23
OBI-100125	100-125	25	1,85
OBI-120140	120-140	25	2,05
OBI-130165	130-165	10	2,30
OBI-150180	150-180	10	2,45



STAL NIERDZEWNA / STAINLESS STEEL			
INDEX	ZAKRES PRACY OPERATING RANGES [mm]	ILOŚĆ [szt.] QUANTITY [pcs]	CENA / PRICE 1 szt. / pcs [PLN]
OBN-00711	7-11	50	1,95
OBN-00812	8-12	50	1,95
OBN-01016	10-16	50	1,95
OBN-01222	12-22	50	2,04
OBN-01320	13-20	50	2,04
OBN-01627	16-27	50	2,04
OBN-02032	20-32	50	2,10
OBN-02540	25-40	50	2,31
OBN-03045	30-45	50	2,40
OBN-03850	38-50	50	2,43
OBN-04060	40-60	50	2,73
OBN-05070	50-70	50	2,82
OBN-06080	60-80	25	3,09
OBN-06885	68-85	25	3,09
OBN-080100	80-100	25	3,45
OBN-087112	87-112	25	3,69
OBN-100125	100-125	25	4,27
OBN-120140	120-140	25	4,70
OBN-130165	130-165	10	4,85
OBN-150180	150-180	10	4,98

**ZASTOSOWANIE:** instalacje wodne, gazowe, paliwowe, wentylacje  
Na zamówienie realizujemy kwasoodporne obejmy ślimakowe i wszelkie obejmy dla branży motoryzacyjnej.

## Opaska GBS - ocynkowana GBS pipe clamp



INDEX	ZAKRES PRACY OPERATING RANGES [mm]	ILOŚĆ [szt.] QUANTITY [pcs]		CENA / PRICE 1 szt. / pcs [PLN]
OBB-02	17-19	50	400	3,20
OBB-03	21-23	50	400	3,31
OBB-04	23-25	50	400	3,40
OBB-06	25-27	50	400	3,51
OBB-08	29-31	50	300	3,80
OBB-10	31-34	50	300	3,92
OBB-12	37-40	50	300	4,20
OBB-14	40-43	50	300	4,32
OBB-15	43-47	50	200	5,13
OBB-16	48-51	50	200	5,26
OBB-18	51-55	50	200	5,66
OBB-20	55-59	50	200	5,80
OBB-22	59-63	50	200	5,92
OBB-24	63-69	50	200	6,03
OBB-26	68-73	25	100	6,25
OBB-28	73-79	25	100	6,45
OBB-30	79-85	25	100	6,65
OBB-31	85-91	25	100	6,80
OBB-32	91-97	25	100	7,00
OBB-34	97-104	25	100	7,15
OBB-35	104-112	25	100	7,35
OBB-36	112-121	25	100	7,50
OBB-38	121-130	25	100	7,75
OBB-40	130-140	10	50	8,84
OBB-42	140-150	10	50	9,04
OBB-44	150-162	10	50	9,24
OBB-46	162-174	10	50	9,45
OBB-48	174-187	10	50	10,04
OBB-50	187-200	5	25	10,88
OBB-52	201-213	5	25	11,12
OBB-54	214-226	5	25	11,54

### Cybant ocynkowany

U-bolt



INDEX	ROZMIAR SIZE [mm]	ŚR. MOCOWANIA DIAMETER OF FIXING [mm]	ILOŚĆ [szt.] QUANTITY [pcs]	CENA / PRICE 1 szt. / pcs [PLN]
CYBB-06023	M6 x 23	1/2"	20	1,76
CYBB-06028	M6 x 28	3/4"	20	1,96
CYBB-06035	M6 x 35	1"	20	1,96
CYBB-06043	M6 x 43	1 1/4"	20	1,76
CYBB-06049	M6 x 49	1 1/2"	20	2,77
CYBB-08023	M8 x 23	1/2"	20	1,90
CYBB-08028	M8 x 28	3/4"	20	2,04
CYBB-08035	M8 x 35	1"	20	2,21
CYBB-08043	M8 x 43	1 1/4"	20	2,52
CYBB-08049	M8 x 49	1 1/2"	20	2,71
CYBB-08061	M8 x 61	2"	20	3,33
CYBB-08077	M8 x 77	2 1/2"	20	3,78
CYBB-08089	M8 x 89	3"	20	4,42
CYBB-08115	M8 x 115	4"	20	4,78
CYBB-10035	M10 x 35	1"	20	3,13
CYBB-10043	M10 x 43	1 1/4"	20	3,47
CYBB-10049	M10 x 49	1 1/2"	20	3,69
CYBB-10061	M10 x 61	2"	20	4,48
CYBB-10077	M10 x 77	2 1/2"	20	6,01
CYBB-10089	M10 x 89	3"	20	6,66

### Łącznik do cybantów ocynkowany

U-bolt connector



INDEX	ROZMIAR SIZE [mm]	PRZEZNACZENIE DESTINY	ILOŚĆ [szt.] QUANTITY [pcs]	CENA / PRICE 1 szt. / pcs [PLN]
CYBŁ-06023	ø6,4 x 29	M6 (1/2")	20	2,24
CYBŁ-06028	ø6,4 x 34	M6 (3/4")	20	2,38
CYBŁ-06035	ø6,4 x 41	M6 (1")	20	2,43
CYBŁ-06043	ø6,4 x 49	M6 (1 1/4")	20	2,69
CYBŁ-06049	ø6,4 x 55	M6 (1 1/2")	20	2,83
CYBŁ-08023	ø8,4 x 31	M8 (1/2")	20	2,24
CYBŁ-08028	ø8,4 x 36	M8 (3/4")	20	2,38
CYBŁ-08035	ø8,4 x 43	M8 (1")	20	2,43
CYBŁ-08043	ø8,4 x 51	M8 (1 1/4")	20	2,69
CYBŁ-08049	ø8,4 x 57	M8 (1 1/2")	20	2,83
CYBŁ-08061	ø8,4 x 69	M8 (2")	20	3,24
CYBŁ-10035	ø10,5 x 45	M10 (1")	20	2,77
CYBŁ-10043	ø10,5 x 53	M10 (1 1/4")	20	3,05
CYBŁ-10049	ø10,5 x 59	M10 (1 1/2")	20	2,83
CYBŁ-10061	ø10,5 x 71	M10 (2")	20	3,24
CYBŁ-10077	ø10,5 x 87	M10 (2 1/2")	20	3,80
CYBŁ-10089	ø10,5 x 99	M10 (3")	20	4,34

### Cybant ocynkowany

U-bolt



INDEX	ZAKRES PRACY OPERATING RANGES [mm]	ILOŚĆ [szt.] QUANTITY [pcs]	CENA / PRICE 1 szt. / pcs [PLN]
CYBK826	8 x 26	25	4,14
CYBK828	8 x 28	25	4,42
CYBK832	8 x 32	25	4,64
CYBK836	8 x 36	25	4,70
CYBK838	8 x 38	25	4,93
CYBK840	8 x 40	25	5,16
CYBK842	8 x 42	25	5,39
CYBK845	8 x 45	20	5,62
CYBK848	8 x 48	20	5,85
CYBK850	8 x 50	20	6,08
CYBK852	8 x 52	20	6,21
CYBK854	8 x 54	15	6,39
CYBK860	8 x 60	15	6,57
CYBK865	8 x 65	15	7,22
CYBK870	8 x 70	15	8,16
CYBK880	8 x 80	10	11,60
CYBK885	8 x 85	10	12,30
CYBK890	8 x 90	10	13,90
CYBK8100	8 x 100	10	15,80

## Złącze kątowe Strengthening angle

ETA-06/0106

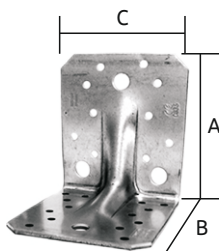

INDEX	RODZAJ TYPE	A [mm]	B [mm]	C [mm]	≠ [mm]	WAGA 1 SZT. WEIGHT 1 PCS [kg]	ILOŚĆ [szt.] QUANTITY [pcs]	CENA / PRICE 1 szt. / pcs [PLN]
ZŁKA-7070	70 wzm	70	70	55	2,0	0,11	100	2,46
ZŁKA-7071	70	70	70	55	2,0	0,11	100	2,40
ZŁKA-7090	90 wzm	90	90	65	2,0	0,21	50	2,70
ZŁKA-709025	90 wzm	90	90	65	2,5	0,22	50	3,22
ZŁKA-7091	90	90	90	65	2,5	0,20	100	3,22
ZŁKA-7105	105 wzm	105	105	90	3,0	0,40	50	5,10
ZŁKA-7105-2	105 wzm	105	105	90	2,0	0,30	50	4,00
ZŁKA-7106	105	105	105	90	3,0	0,40	50	5,10

## Złącze kątowe 90x48x3,0x... Strengthening angle

ETA-06/0106

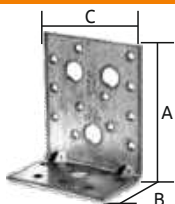

INDEX	RODZAJ TYPE	A [mm]	B [mm]	C [mm]	≠ [mm]	WAGA 1 SZT. WEIGHT 1 PCS [kg]	ILOŚĆ [szt.] QUANTITY [pcs]	CENA / PRICE 1 szt. / pcs [PLN]
ZŁKA-7048	90x48x3,0x48	90	48	48	3,0	0,13	100	4,20
ZŁKA-7076	90x48x3,0x76	90	48	76	3,0	0,21	100	6,20
ZŁKA-7116	90x48x3,0x116	90	48	116	3,0	0,34	50	9,40

## Złącze kątowe 60280 Strengthening angle

ETA-06/0106

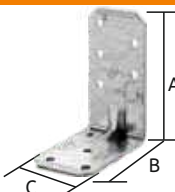

INDEX	RODZAJ TYPE	A [mm]	B [mm]	C [mm]	≠ [mm]	WAGA 1 SZT. WEIGHT 1 PCS [kg]	ILOŚĆ [szt.] QUANTITY [pcs]	CENA / PRICE 1 szt. / pcs [PLN]
ZŁKA-7680	60280	83	62	40	2,0	0,08	100	2,22

## Złącze kątowe 6090-6191 Strengthening angle

ETA-06/0106

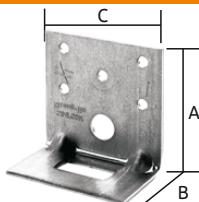

INDEX	RODZAJ TYPE	A [mm]	B [mm]	C [mm]	≠ [mm]	WAGA 1 SZT. WEIGHT 1 PCS [kg]	ILOŚĆ [szt.] QUANTITY [pcs]	CENA / PRICE 1 szt. / pcs [PLN]
ZŁKA-7690	6090	90	60	60	2,5	0,16	100	4,70

## Złącze kątowe 6292 Angle with regulation

ETA-06/0106

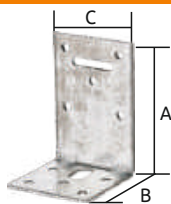

INDEX	RODZAJ TYPE	A [mm]	B [mm]	C [mm]	≠ [mm]	WAGA 1 SZT. WEIGHT 1 PCS [kg]	ILOŚĆ [szt.] QUANTITY [pcs]	CENA / PRICE 1 szt. / pcs [PLN]
ZŁKA-7692	6292	90	60	60	2,5	0,16	100	4,70

## Złącze kątowe 40390 Connection angle

ETA-06/0106

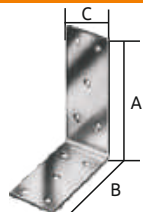

INDEX	RODZAJ TYPE	A [mm]	B [mm]	C [mm]	≠ [mm]	WAGA 1 SZT. WEIGHT 1 PCS [kg]	ILOŚĆ [szt.] QUANTITY [pcs]	CENA / PRICE 1 szt. / pcs [PLN]
ZŁKA-7390	40390	93	93	40	3,0	0,16	100	3,12

## Złącze kątowe 40312-40412 Connection angle

ETA-06/0106

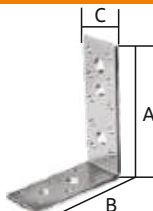

INDEX	RODZAJ TYPE	A [mm]	B [mm]	C [mm]	≠ [mm]	WAGA 1 SZT. WEIGHT 1 PCS [kg]	ILOŚĆ [szt.] QUANTITY [pcs]	CENA / PRICE 1 szt. / pcs [PLN]
ZŁKA-7312	40312	119	91	40	3,0	0,18	100	4,80
ZŁKA-7412	40412	120	92	40	4,0	0,24	100	5,94

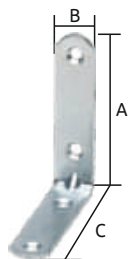
Kątownik wąski  
Narrow angle

INDEX	RODZAJ TYPE	A [mm]	B [mm]	C [mm]	≠ [mm]	WAGA 1 SZT. WEIGHT 1 PCS [kg]	ILOŚĆ [szt.] QUANTITY [pcs]	CENA / PRICE 1 szt. / pcs [PLN]
ZŁKA-0302	SEC 30/2	30	15	30	2,0	0,01	500	0,98
ZŁKA-0402	SEC 40/2	40	15	40	2,0	0,02	500	1,05
ZŁKA-0502	SEC 50/2	50	15	50	2,0	0,02	500	1,18
ZŁKA-0602	SEC 60/2	60	15	60	2,0	0,03	500	1,39
ZŁKA-0702	SEC 70/2	70	15	70	2,5	0,04	500	1,56
ZŁKA-0802	SEC 80/2	80	15	80	2,5	0,05	200	1,90
ZŁKA-1003	SEC100/3	100	18	100	3,0	0,08	200	5,67
ZŁKA-1203	SEC120/3	120	18	120	3,0	0,10	200	5,44
ZŁKA-1403	SEC140/3	140	18	140	3,0	0,12	200	7,90

Złącze kątowe 35350-55365  
Connection angle

ETA- 06/0106

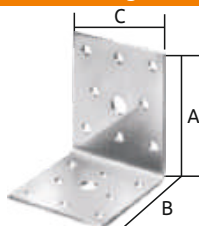

INDEX	RODZAJ TYPE	A [mm]	B [mm]	C [mm]	≠ [mm]	WAGA 1 SZT. WEIGHT 1 PCS [kg]	ILOŚĆ [szt.] QUANTITY [pcs]	CENA / PRICE 1 szt. / pcs [PLN]
ZŁKA-7350	35350	50	50	35	2,0	0,06	100	1,90
ZŁKA-7365	55365	65	65	55	2,5	0,15	100	3,44

Złącze kątowe  
Connection angle

ETA- 06/0106

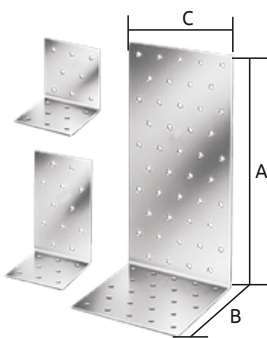

INDEX	RODZAJ TYPE	A [mm]	B [mm]	C [mm]	≠ [mm]	WAGA 1 SZT. WEIGHT 1 PCS [kg]	ILOŚĆ [szt.] QUANTITY [pcs]	CENA / PRICE 1 szt. / pcs [PLN]
ZŁKA-30001	40x40x2,0x25	40	40	25	2,0	0,03	200	1,48
ZŁKA-30444	40x40x2,0x40	40	40	40	2,0	0,05	200	1,70
ZŁKA-30446	40x40x2,0x60	40	40	60	2,0	0,07	200	2,39
ZŁKA-30003	40x60x2,0x25	40	60	25	2,0	0,04	200	2,15
ZŁKA-30005	60x60x2,0x25	60	60	25	2,0	0,05	200	2,22
ZŁKA-30664	60x60x2,0x40	60	60	40	2,0	0,07	150	1,92
ZŁKA-30666	60x60x2,0x60	60	60	60	2,0	0,11	100	2,40
ZŁKA-30668	60x60x2,0x80	60	60	80	2,0	0,14	100	3,29
ZŁKA-30886	80x80x2,0x60	80	80	60	2,0	0,14	100	3,40
ZŁKA-30888	80x80x2,0x80	80	80	80	2,0	0,19	50	3,54
ZŁKA-8116	100x100x2,5x60	100	100	60	2,5	0,22	50	5,41
ZŁKA-8118	100x100x2,5x80	100	100	80	2,5	0,30	50	6,86
ZŁKA-8111	100x100x2,5x100	100	100	100	2,5	0,37	50	7,28

Płytki perforowana  
Perforated plate

EN 14545

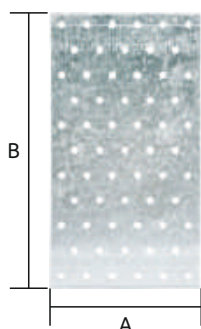

INDEX	A [mm]	B [mm]	≠ [mm]	WAGA 1 SZT. WEIGHT 1 PCS [kg]	ILOŚĆ [szt.] QUANTITY [pcs]	CENA / PRICE 1 szt. / pcs [PLN]
PP-20525	40	120	2	0,07	50	1,40
PP-20530	40	160	2	0,09	50	2,05
PP-20535	50	200	2	0,15	50	3,09
PP-20540	60	140	2	0,12	50	2,27
PP-20545	60	200	2	0,18	50	3,18
PP-20550	60	240	2	0,22	50	4,19
PP-20555	80	200	2	0,23	50	3,62
PP-20560	80	240	2	0,29	50	4,90
PP-20565	80	300	2	0,35	50	6,73
PP-20575	100	200	2	0,30	50	4,41
PP-20580	100	240	2	0,35	50	5,08
PP-20590	100	300	2	0,45	25	8,53
PP-20595	120	200	2	0,35	50	5,95
PP-20600	120	240	2	0,41	50	7,28
PP-20610	120	300	2	0,53	25	8,82

## Złącze uniwersalne

Universal connector

ETA-07/0137

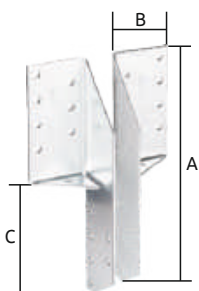

INDEX	RODZAJ TYPE	A [mm]	B [mm]	C [mm]	≠ [mm]	WAGA 1 SZT. WEIGHT 1 PCS [kg]	ILOŚĆ [szt.] QUANTITY [pcs]	CENA / PRICE 1 szt. / pcs [PLN]
ZŁ-1000	MAXI 190 L	192	49,5	96	2,0	0,20	50	7,40
ZŁ-1002	MAXI 190 P	192	49,5	96	2,0	0,20	50	7,40
ZŁ-1100	MIDI 130 L	130	62,5	58	2,0	0,24	50	7,10
ZŁ-1101	MIDI 130 P	130	62,5	58	2,0	0,24	50	7,10
ZŁ-1200	MINI 100 L	100	62,5	40	2,0	0,15	100	4,40
ZŁ-1201	MINI 100 P	100	62,5	40	2,0	0,15	100	4,40

## Złącze krokwiowo - płatwiowe

Rafter bracket

ETA-07/0137

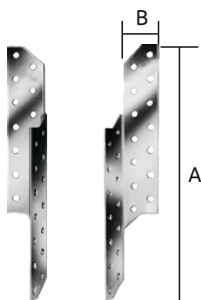

INDEX	RODZAJ TYPE	A [mm]	B [mm]	≠ [mm]	WAGA 1 SZT. WEIGHT 1 PCS [kg]	ILOŚĆ [szt.] QUANTITY [pcs]	CENA / PRICE 1 szt. / pcs [PLN]
KOK-2170	170L	170	34,5	2,0	0,10	100	2,66
KOK-2171	170P	170	34,5	2,0	0,10	100	2,66
KOK-2210	210L	210	34,5	2,0	0,13	100	3,25
KOK-2211	210P	210	34,5	2,0	0,13	100	3,25
KOK-2250	250L	250	34,5	2,0	0,17	100	4,42
KOK-2251	250P	250	34,5	2,0	0,17	100	4,42
KOK-2290	290L	290	34,5	2,0	0,21	100	5,80
KOK-2291	290P	290	34,5	2,0	0,21	100	5,80

## Wspornik belki

Beam hanger

ETA-06/0270

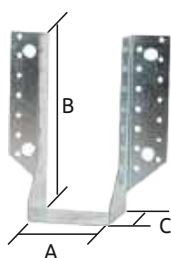

INDEX	A [mm]	B [mm]	C [mm]	≠ [mm]	WAGA 1 SZT. WEIGHT 1 PCS [kg]	ILOŚĆ [szt.] QUANTITY [pcs]	CENA / PRICE 1 szt. / pcs [PLN]
WSB-3103	40	110	60	2,0	0,27	50	8,10
WSB-3109	51	104	60	2,0	0,27	50	7,00
WSB-3209	60	130	60	2,0	0,38	50	8,60
WSB-3215	70	125	60	2,0	0,38	50	9,60
WSB-3221	80	120	60	2,0	0,38	50	7,60
WSB-3318	100	140	60	2,0	0,43	40	9,70
WSB-3421	120	160	60	2,0	0,58	25	11,80

## Wspornik belki

Beam hanger

ETA-06/0270

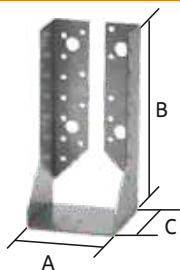

INDEX	A [mm]	B [mm]	C [mm]	≠ [mm]	WAGA 1 SZT. WEIGHT 1 PCS [kg]	ILOŚĆ [szt.] QUANTITY [pcs]	CENA / PRICE 1 szt. / pcs [PLN]
WSBI-4103	40	105	76	2,0	0,25	50	8,60
WSBI-4109	51	99,5	76	2,0	0,25	50	8,20
WSBI-4112	60	95	76	2,0	0,26	50	8,20
WSBI-4221	80	130	76	2,0	0,38	50	10,80
WSBI-4318	100	140	76	2,0	0,43	40	13,00

## Wspornik belki dzielony

Beam hanger

ETA-06/0270

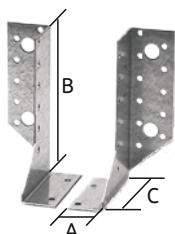

INDEX	A [mm]	B [mm]	C [mm]	≠ [mm]	WAGA OPAKOWANIA PACKAGING WEIGHT [kg]	ILOŚĆ [szt.] QUANTITY [pcs]	CENA / PRICE 1 szt. / pcs [PLN]
WSBD-30030	30	118	84	2,0	9	50	7,70
WSBD-34030	30	138	84	2,0	11	50	7,90
WSBD-38030	30	158	84	2,0	13	50	8,20
WSBD-44030	30	188	84	2,0	14,5	50	8,40

## Pasek perforowany

Perforated belt

EN 14545

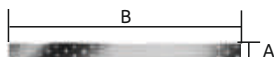

INDEX	RODZAJ TYPE	A [mm]	B [mm]	≠ [mm]	WAGA 1 SZT. WEIGHT 1 PCS [kg]	ILOŚĆ [szt.] QUANTITY [pcs]	CENA / PRICE 1 szt. / pcs [PLN]
PAP-20040	40x1200x2,0	40	1200	2,0	0,70	30	16,00
PAP-20060	60x1200x2,0	60	1200	2,0	1,05	20	22,40
PAP-20080	80x1200x2,0	80	1200	2,0	1,39	15	33,60
PAP-20100	100x1200x2,0	100	1200	2,0	1,71	10	40,80
PAP-20120	120x1200x2,0	120	1200	2,0	2,07	10	48,90

## Taśma perforowana

Perforated banding

EN 14545

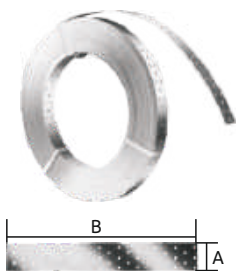

INDEX	RODZAJ TYPE	A [mm]	B [mm]	≠ [mm]	WAGA 1 SZT. WEIGHT 1 PCS [kg]	ILOŚĆ [szt.] QUANTITY [pcs]	CENA / PRICE 1 szt. / pcs [PLN]
TP-27210	20x1,0x25	20	25	1,0	3,80	1	102,00
TP-27115	20x1,5x10	20	10	1,5	2,29	1	59,20
TP-27120	25x2,0x10	25	10	2,0	3,98	1	102,00
TP-27252	25x2,0x25	25	25	2,0	9,50	1	170,60
TP-27419	40x2,0x25	40	25	2,0	15,00	1	276,60
TP-27420	40x2,0x50	40	50	2,0	30,00	1	509,00
TP-27620	60x2,0x50	60	50	2,0	46,20	1	956,00
TP-27820	80x2,0x25	80	25	2,0	29,70	1	738,00

## Dwustronny łącznik do drewna

Double sided timber connector

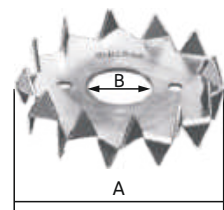

INDEX	A [mm]	B [mm]	WAGA 1 SZT. WEIGHT 1 PCS [kg]	ILOŚĆ [szt.] QUANTITY [pcs]	CENA / PRICE 1 szt. / pcs [PLN]
BUL-80210	D 48	17	0,02	200	2,60
BUL-80220	D 62	21	0,04	100	4,50
BUL-80230	D 75	26	0,05	100	5,50
BUL-80240	D 95	33	0,09	40	10,40
BUL-80250	D 117	48	0,16	25	21,00

## Wkręt

Screw



INDEX	ROZMIAR SIZE [mm]	WAGA OPAKOWANIA PACKAGING WEIGHT [kg]	ILOŚĆ [szt.] QUANTITY [pcs]	CENA / PRICE 250 szt. / pcs [PLN]
GW-525	5,0 x 25	0,63	250	54,00
GW-535	5,0 x 35	0,94	250	60,00
GW-540	5,0 x 40	0,97	250	68,00
GW-550	5,0 x 50	1,15	250	76,00

## Gwoździe krokwiowe

Rafter nails



INDEX	ROZMIAR SIZE [mm]	WAGA OPAKOWANIA PACKAGING WEIGHT [kg]	ILOŚĆ [szt.] QUANTITY [pcs]	CENA / PRICE 1000 szt. / pcs [PLN]
GK-69911	6,0 x 110	15,00	500	1200,00
GK-69915	6,0 x 150	20,00	500	1360,00
GK-69918	6,0 x 180	10,00	250	1580,00
GK-69921	6,0 x 210	15,00	250	1850,00
GK-69923	6,0 x 230	15,00	250	2330,00
GK-69926	6,0 x 260	7,50	125	2460,00
GK-69928	6,0 x 280	8,75	125	2710,00
GK-69930	6,0 x 300	8,75	125	2940,00
GK-69933	6,0 x 330	10,00	125	3160,00
GK-69936	6,0 x 360	10,00	125	3730,00

### Wspornik stupa Pole base

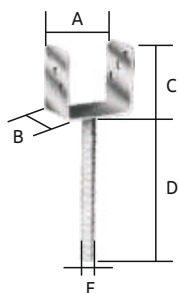

INDEX	A [mm]	B [mm]	C [mm]	D [mm]	E [mm]	∅ [mm]	WAGA 1 SZT. / WEIGHT 1 PCS [kg]	ILOŚĆ [szt.] / QUANTITY [pcs]	CENA / PRICE 1 szt. / pcs [PLN]
<b>WSP-070</b>	75	60	100	200	16	4,3	0,81	20	21,40
<b>WSP-080</b>	83	60	100	200	16	4,3	0,84	20	21,70
<b>WSP-090</b>	92	60	100	200	16	4,3	0,85	20	22,00
<b>WSP-100</b>	102	60	100	200	16	4,3	0,87	20	22,40
<b>WSP-120</b>	122	60	100	200	16	4,3	0,92	20	22,70
<b>WSP-140</b>	142	60	100	200	16	4,3	0,94	20	23,00

### Wspornik stupa regulowany bez podstawy Pole base with regulation U type

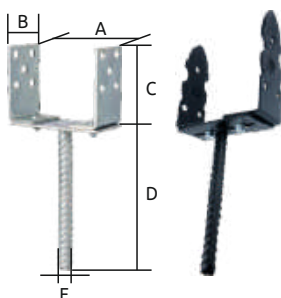

WSSR-01

WSSR-01L

INDEX	A [mm]	B [mm]	C [mm]	D [mm]	E [mm]	∅ [mm]	KOLOR / COLOR	ILOŚĆ [szt.] / QUANTITY [pcs]	CENA / PRICE 1 szt. / pcs [PLN]
<b>WSSR-01</b>	0-150	60	110	200	18	3,0	ocynk / zinc	10	18,70
<b>WSSR-0140</b>	0-150	60	110	400	18	3,0	ocynk / zinc	10	22,96
<b>WSSR-01L *</b>	120-210	60	180	190	20	3,6	czarny / black	1	21,78

\* lakierowany proszkowo na czarno / black powder coated

### Wspornik stupa regulowany z podstawą Pole base with regulation T type

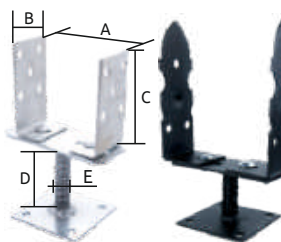

WSSR-02

WSSR-02L

INDEX	A [mm]	B [mm]	C [mm]	D [mm]	E [mm]	∅ [mm]	KOLOR / COLOR	ILOŚĆ [szt.] / QUANTITY [pcs]	CENA / PRICE 1 szt. / pcs [PLN]
<b>WSSR-02</b>	0-150	57	110	60	18	3,0	ocynk / zinc	10	18,70
<b>WSSR-02L *</b>	120-210	60	180	65	20	3,6	czarny / black	1	22,72

\* lakierowany proszkowo na czarno / black powder coated

Rozmiar podstawy (the size of the base): 100 x 100 mm

### Wspornik stupa wbijany Wood post anchor



INDEX	SZEROKOŚĆ / WIDTH [mm]	DŁUGOŚĆ / LENGTH [mm]	ILOŚĆ [szt.] / QUANTITY [pcs]	CENA / PRICE 1 szt. / pcs [PLN]
<b>WSSW-050</b>	50 x 50	750	1	26,00
<b>WSSW-070</b>	70 x 70	750	1	28,40
<b>WSSW-080</b>	80 x 80	750	1	31,45
<b>WSSW-090</b>	90 x 90	750	1	35,50
<b>WSSW-100</b>	100 x 100	750	1	38,00
<b>WSSW-120</b>	120 x 120	750	1	44,50

## Podkładka ciesielska kwadratowa prosta

Square carpenter washer

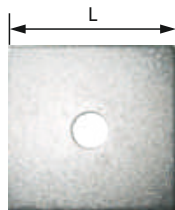

INDEX	ŚREDNICA OTWORU HOLE DIAMETER [mm]	L [mm]	ILOŚĆ [szt.] QUANTITY [pcs]	CENA / PRICE 1 szt. / pcs [PLN]
PCP-10	10	80	50	2,53
PCP-12	12	80	50	2,53
PCP-14	14	80	50	2,53
PCP-16	16	80	50	2,53
PCP-20	20	80	50	2,53

## Podkładka ciesielska kwadratowa przetłaczana

Square carpenter washer

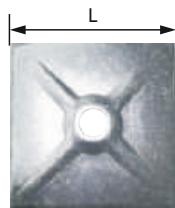

INDEX	ŚREDNICA OTWORU HOLE DIAMETER [mm]	L [mm]	ILOŚĆ [szt.] QUANTITY [pcs]	CENA / PRICE 1 szt. / pcs [PLN]
PCPRZ-08	8	80	50	2,75
PCPRZ-10	10	80	50	2,75
PCPRZ-12	12	80	50	2,75
PCPRZ-14	14	80	50	2,75
PCPRZ-16	16	80	50	2,75

## Ceownik wzmocniony (2mb)

Support Channel

PN-EN 61537:2007



INDEX	≠ [mm]	SZEROKOŚĆ WIDTH [mm]	DŁUGOŚĆ LENGTH [mm]	WYSOKOŚĆ HEIGHT [mm]	WAGA 1 SZT. WEIGHT 1 PCS [kg]	CENA / PRICE 1 szt. / pcs [PLN]
BAKS-CWZ1220	1,2	40	40	22	1,60	16,49
BAKS-CWZ1520	1,5	40	40	22	2,03	18,57
BAKS-CWZ-020	2,0	40	40	22	2,68	22,66
BAKS-CWZ1235	1,2	40	40	35	2,02	21,61
BAKS-CWZ1535	1,5	40	40	35	2,32	26,62
BAKS-CWZ2035	2,0	40	40	35	3,02	33,32
BAKS-CWZ1240	1,2	40	40	40	2,20	22,38
BAKS-CWZ1540	1,5	40	40	40	2,60	25,23
BAKS-CWZ2040	2,0	40	40	40	3,50	33,16

## Ceownik (2mb)

Channel

PN-EN 61537:2007



INDEX	≠ [mm]	SZEROKOŚĆ WIDTH [mm]	DŁUGOŚĆ LENGTH [mm]	WYSOKOŚĆ HEIGHT [mm]	WAGA 1 SZT. WEIGHT 1 PCS [kg]	CENA / PRICE 1 szt. / pcs [PLN]
BAKS-C1228	1,2	28	2000	12	0,84	9,34
BAKS-C1528	1,5	28	2000	12	0,92	10,43
BAKS-C2028	2,0	28	2000	12	1,16	13,88
BAKS-C1240	1,2	40	2000	20	1,46	13,98
BAKS-C1540	1,5	40	2000	20	1,56	16,35
BAKS-C2040	2,0	40	2000	20	2,10	21,26
BAKS-C3050	3,0	50	2000	30	4,48	46,30

## Ceownik montażowy (2mb)

Support Channel

PN-EN 61537:2007



INDEX	≠ [mm]	SZEROKOŚĆ WIDTH [mm]	DŁUGOŚĆ LENGTH [mm]	WYSOKOŚĆ HEIGHT [mm]	WAGA 1 SZT. WEIGHT 1 PCS [kg]	ILOŚĆ [szt.] QUANTITY [pcs]	CENA / PRICE 1 szt. / pcs [PLN]
BAKS-CM154121	1,5	41	2000	21	2,34	12	20,45
BAKS-CM204121	2,0	41	2000	21	3,12	12	24,48
BAKS-CM154141	1,5	41	2000	41	2,64	12	27,80
BAKS-CM204141	2,0	41	2000	41	3,56	12	35,30
BAKS-CM155050	1,5	50	2000	50	3,80	12	33,53
BAKS-CM205050	2,0	50	2000	50	5,36	12	42,98

## Podstawa wspornika

Fixing Channel

PN-EN 61537:2007



INDEX	DŁUGOŚĆ LENGTH [mm]	WAGA 1 SZT. WEIGHT 1 PCS [kg]	ILOŚĆ [szt.] QUANTITY [pcs]	CENA / PRICE 1 szt. / pcs [PLN]
BAKS-PWŚ01	110	0,09	100	1,91
BAKS-PWŚ02	200	0,23	30	3,97
BAKS-PWŚ03	300	0,33	30	5,96
BAKS-PWŚ04	400	0,43	30	7,68
BAKS-PWŚ05	500	0,53	30	9,01
BAKS-PWŚ1	1000	1,06	10	15,23
BAKS-PWŚ2	2000	2,01	8	30,45
BAKS-PWŚ3	3000	3,10	8	45,68

## Wysięgnik wzmocniony

Bracket

PN-EN 61537:2007



INDEX	SZEROKOŚĆ WIDTH [mm]	WYSOKOŚĆ HEIGHT [mm]	WAGA 1 SZT. WEIGHT 1 PCS [kg]	ILOŚĆ [szt.] QUANTITY [pcs]	CENA / PRICE 1 szt. / pcs [PLN]
BAKS-WW050	60	48	0,05	100	1,44
BAKS-WW100	110	70	0,09	100	1,88
BAKS-WW150	160	70	0,12	100	2,56
BAKS-WW200	210	75	0,22	100	3,00
BAKS-WW250	260	75	0,26	50	4,61
BAKS-WW300	315	95	0,40	50	5,28
BAKS-WW400	415	95	0,57	50	8,28
BAKS-WW500	515	95	0,80	50	9,85
BAKS-WW600	615	95	0,91	50	11,73

## Kątownik (2mb)

Angle profile

PN-EN 61537:2007

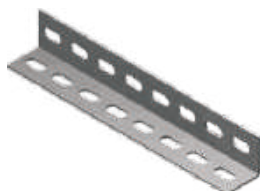

INDEX	≠ [mm]	SZEROKOŚĆ WIDTH [mm]	WYSOKOŚĆ HEIGHT [mm]	WAGA 1 SZT. WEIGHT 1 PCS [kg]	ILOŚĆ [szt.] QUANTITY [pcs]	CENA / PRICE 1mb [PLN]
BAKS-KA1225	1,2	25	25	0,80	10	4,30
BAKS-KA1235	1,2	35	35	1,08	10	5,94
BAKS-KA1525	1,5	25	25	0,82	10	5,15
BAKS-KA1535	1,5	35	35	1,30	10	7,13
BAKS-KA2025	2,0	25	25	1,08	10	6,64
BAKS-KA2035	2,0	35	35	1,58	10	9,21
BAKS-KA3050	3,0	50	50	4,00	10	20,45

## Płaskownik (2mb)

Punch flat bar

PN-EN 61537:2007



INDEX	≠ [mm]	SZEROKOŚĆ WIDTH [mm]	WAGA 1 SZT. WEIGHT 1 PCS [kg]	ILOŚĆ [szt.] QUANTITY [pcs]	CENA / PRICE 1mb [PLN]
BAKS-PŁ1212	1,2	12	0,10	50	1,94
BAKS-PŁ1516	1,5	16	0,17	50	2,80
BAKS-PŁ1525	1,5	25	0,25	50	3,62
BAKS-PŁ2025	2,0	25	0,30	50	4,24
BAKS-PŁ2525	2,5	25	0,37	50	4,51
BAKS-PŁ3030	3,0	30	0,45	50	6,84

### Szyna perforowana "EURO" (1m)

Perforated rail

PN-EN 61537:2007



INDEX	∅ [mm]	SZEROKOŚĆ WIDTH [mm]	WYSOKOŚĆ HEIGHT [mm]	WAGA 1 SZT. WEIGHT 1 PCS [kg]	ILOŚĆ [szt.] QUANTITY [pcs]	CENA / PRICE 1 szt. / pcs [PLN]
BAKS-SZPE07	1,0	35	7	0,29	50	3,83
BAKS-SZPE15	1,0	35	15	0,40	50	5,13

### Drabinka kablowa H45 (3mb)

Cable Ladder

PN-EN 61537:2007



INDEX	WYSOKOŚĆ HEIGHT [mm]	ILOŚĆ [szt.] QUANTITY [pcs]	DKP ≠ 1,5mm		DKC ≠ 2,0mm	
			WAGA WEIGHT [1mb/kg]	CENA / PRICE 1 mb [PLN]	WAGA WEIGHT [1mb/kg]	CENA / PRICE 1 mb [PLN]
BAKS-DK100	45	1	2,06	22,70	2,74	28,76
BAKS-DK200	45	1	2,33	24,01	3,10	30,54
BAKS-DK300	45	1	2,61	25,98	3,48	33,13
BAKS-DK400	45	1	3,02	27,93	4,02	35,71
BAKS-DK500	45	1	3,15	29,90	4,20	38,29
BAKS-DK600	45	1	3,43	31,84	4,57	40,88

### Korytka kablowe metalowe (2mb)

Cable Tray

PN-EN 61537:2007



INDEX	WYSOKOŚĆ HEIGHT [mm]	SZEROKOŚĆ WIDTH [mm]	KGR ≠ 0,5mm		KGL ≠ 0,7mm		KGJ ≠ 1,0mm	
			WAGA WEIGHT [1mb/kg]	CENA / PRICE 1 mb [PLN]	WAGA WEIGHT [1mb/kg]	CENA / PRICE 1 mb [PLN]	WAGA WEIGHT [1mb/kg]	CENA / PRICE 1 mb [PLN]
BAKS-KGR035	30	35	0,42	5,24	0,57	7,24	0,76	9,69
BAKS-KGR050	42	50	0,55	6,12	0,76	8,45	1,08	11,28
BAKS-KGR100	42	100	0,73	8,03	1,00	10,91	1,41	13,70
BAKS-KGR150	42	150	0,92	9,57	1,26	13,80	1,75	16,73
BAKS-KGR200	42	200	1,10	11,33	1,51	16,24	2,08	20,77
BAKS-KGR300	42	300	1,45	15,84	1,99	22,17	2,74	26,67

### Pokrywa korytka kablowego (2mb)

Cover

PN-EN 61537:2007



INDEX	SZEROKOŚĆ WIDTH [mm]	PKR ≠ 0,5mm		PKL ≠ 0,7mm		PKJ ≠ 1,0mm	
		WAGA WEIGHT [1mb/kg]	CENA / PRICE 1 mb [PLN]	WAGA WEIGHT [1mb/kg]	CENA / PRICE 1 mb [PLN]	WAGA WEIGHT [1mb/kg]	CENA / PRICE 1 mb [PLN]
BAKS-PKR035	35	0,18	2,72	-	-	-	-
BAKS-PKR050	50	0,28	3,27	0,42	3,52	0,64	4,55
BAKS-PKR100	100	0,45	4,97	0,72	6,34	1,04	7,99
BAKS-PKR150	150	0,67	6,09	1,02	8,58	1,44	10,67
BAKS-PKR200	200	0,86	7,68	1,32	11,73	1,84	14,51
BAKS-PKR300	300	1,25	11,57	1,92	16,17	2,64	21,01

## Podkładka okrągła, zgrubna - ocynkowana

Round washer

PN-82005 / DIN 125A

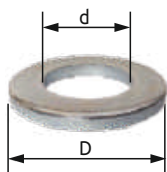

INDEX	M	d [mm]	D [mm]	WAGA 1000 szt. WEIGHT 1000 pcs [kg]	ILOŚĆ [szt./kg] QUANTITY [pcs/kg]	ILOŚĆ [kg] QUANTITY [kg]	CENA / PRICE 1 kg [PLN]	
POD-03	M3	3,2	7,0	0,12	8403	5	20	18,40
POD-04	M4	4,3	9,0	0,31	3247	5	20	15,10
POD-05	M5	5,3	10,0	0,44	2257	5	20	13,50
POD-06	M6	6,4	12,0	1,02	980	5	20	10,80
POD-08	M8	8,4	16,0	1,83	546	5	20	9,50
POD-10	M10	10,5	20,0	3,57	280	5	20	9,50
POD-12	M12	13,0	24,0	6,27	159	5	20	9,50
POD-14	M14	15,0	28,0	8,62	116	5	20	9,50
POD-16	M16	17,0	30,0	11,3	88	5	20	9,50
POD-18	M18	19,0	34,0	14,7	68	5	20	9,50
POD-20	M20	21,0	37,0	17,2	58	5	20	9,50
POD-22	M22	23,0	39,0	18,3	55	5	20	10,00
POD-24	M24	25,0	44,0	32,3	31	5	20	10,00
POD-27	M27	28,0	50,0	42,3	24	5	20	10,00
POD-30	M30	31,0	56,0	53,6	19	5	20	10,00

## Podkładka okrągła, poszerzona - ocynkowana

Enlarged round washer

PN-82030 / DIN 9021

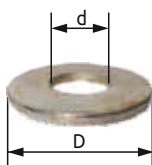

INDEX	M	d [mm]	D [mm]	WAGA 1000 szt. WEIGHT 1000 pcs [kg]	ILOŚĆ [szt./kg] QUANTITY [pcs/kg]	ILOŚĆ [kg] QUANTITY [kg]	CENA / PRICE 1 kg [PLN]	
POP-3004	M4	4,3	12,0	0,77	1292	5	20	14,50
POP-3005	M5	5,3	15,0	1,46	685	5	20	13,50
POP-3006	M6	6,4	18,0	2,79	358	5	20	9,90
POP-3008	M8	8,4	24,0	6,23	161	5	20	9,30
POP-3010	M10	10,5	30,0	12,2	82	5	20	9,30
POP-3012	M12	13,0	37,0	22,2	45	5	20	9,30
POP-3014	M14	15,0	44,0	31,6	32	5	20	9,30
POP-3016	M16	17,0	50,0	40,9	24	5	20	9,30
POP-3018	M18	19,0	56,0	67,4	15	5	20	9,30
POP-3020	M20	21,0	60,0	76,8	13	5	20	9,30
POP-3022	M22	23,0	66,0	89,8	11	5	20	9,50
POP-3024	M24	25,0	72,0	139,0	7	5	20	9,50
POP-3027	M27	30,0	85,0	175,0	6	5	20	9,50
POP-3030	M30	33,0	92,0	273,0	4	5	20	9,50

## Podkładka okrągła, poszerzona - ocynkowana

Enlarged round washer

PN-82019 / DIN 440R

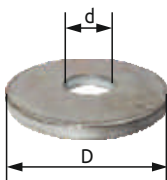

INDEX	M	d [mm]	D [mm]	WAGA 1000 szt. WEIGHT 1000 pcs [kg]	ILOŚĆ [szt./kg] QUANTITY [pcs/kg]	ILOŚĆ [kg] QUANTITY [kg]	CENA / PRICE 1 kg [PLN]	
POP-1904	M4	4,5	13,9	1,7	574	5	20	14,50
POP-1905	M5	5,6	17,8	3,6	276	5	20	13,50
POP-1906	M6	6,6	21,7	5,4	184	5	20	9,90
POP-1908	M8	9,2	26,8	13,0	77	5	20	9,30
POP-1910	M10	11,1	33,7	19,1	52	5	20	9,30
POP-1912	M12	13,4	42,2	43,3	23	5	20	9,30
POP-1914	M14	15,6	49,6	55,7	18	5	20	9,30
POP-1916	M16	17,7	54,7	87,2	11	5	20	9,30
POP-1918	M18	19,5	62,0	114,6	9	5	20	9,30
POP-1920	M20	22,5	70,4	174,0	6	5	20	9,30
POP-1922	M22	24,0	80,0	215,0	5	5	20	9,50
POP-1924	M24	24,5	85,0	242,0	4	5	20	9,50
POP-1927	M27	30,0	98,0	322,0	3	5	20	9,50
POP-1930	M30	33,0	105,0	368,0	3	5	20	9,50

## Podkładka sprężysta - ocynkowana

Spring washer

PN-82008 / DIN 127B

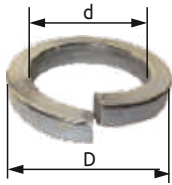

INDEX	M	d [mm]	D [mm]	WAGA 1000 szt. WEIGHT 1000 pcs [kg]	ILOŚĆ [szt./kg] QUANTITY [pcs/kg]	ILOŚĆ [kg] QUANTITY [kg]	CENA / PRICE 1 kg [PLN]	
PODS-03	M3	3,1	4,3	0,11	9091	5	20	24,00
PODS-04	M4	4,2	6,2	0,18	5556	5	20	22,00
PODS-05	M5	5,2	8,8	0,36	2778	5	20	17,00
PODS-06	M6	6,2	11,3	0,83	1205	5	20	12,50
PODS-08	M8	8,2	14,0	1,60	625	5	20	12,00
PODS-10	M10	10,2	17,4	2,53	395	5	20	12,00
PODS-12	M12	12,2	20,3	3,82	262	5	20	12,00
PODS-14	M14	14,5	23,5	6,01	166	5	20	12,00
PODS-16	M16	16,6	26,5	8,91	112	5	20	12,00
PODS-18	M18	18,6	29,4	9,80	102	5	20	12,00
PODS-20	M20	20,8	32,6	15,20	66	5	20	12,00
PODS-24	M24	25,6	39,6	26,20	38	5	20	12,00
PODS-27	M27	28,4	48,0	31,20	32	5	20	12,00
PODS-30	M30	31,4	56,0	44,30	23	5	20	12,00

## Podkładka kwadratowa do konstrukcji drewnianych - ocynkowana

Wood construction washer

DIN 436



INDEX	M	d [mm]	D [mm]	WAGA 1000 szt. WEIGHT 1000 pcs [kg]	ILOŚĆ [szt./kg] QUANTITY [pcs/kg]	ILOŚĆ [kg] QUANTITY [kg]	CENA / PRICE 1 kg [PLN]	
POK-10	M10	12,0	30,0	20,0	50	5	20	9,50
POK-12	M12	14,0	40,0	45,7	22	5	20	9,50
POK-14	M14	16,0	40,0	51,2	19	5	20	9,50
POK-16	M16	18,0	50,0	88,7	11	5	20	9,50
POK-18	M18	20,0	50,0	97,7	10	5	20	9,50
POK-20	M20	22,0	60,0	126,0	8	5	20	9,50
POK-24	M24	26,0	70,0	275,0	4	5	20	9,50

## Nakrętka pazurkowa - ocynkowana

T-nut

DIN 1624



INDEX	ROZMIAR SIZE [mm]	OPAKOWANIE [szt.] PACKAGE [pcs]	ILOŚĆ [kg] QUANTITY [kg]	CENA / PRICE 1000 szt./pcs [PLN]	
NAKP0609	M6 x 9	100	5	20	82,00
NAKP0612	M6 x 12	100	5	20	95,00
NAKP0811	M8 x 11	50	5	20	123,00

## Nakrętka sześciokątna - ocynkowana

Metric hexagon nut zinc

DIN 934



Klasa 4			Klasa 8		
INDEX	M	CENA / PRICE 1 kg [PLN]	INDEX	M	CENA / PRICE 1 kg [PLN]
NAK-03	M3	15,00	NAK8-06	M6	12,20
NAK-04	M4	12,70	NAK8-08	M8	12,20
NAK-05	M5	10,50	NAK8-10	M10	12,20
NAK-06	M6	9,00	NAK8-12	M12	12,20
NAK-08	M8	8,50	NAK8-14	M14	12,20
NAK-10	M10	8,50	NAK8-16	M16	12,20
NAK-12	M12	8,50	NAK8-18	M18	12,20
NAK-14	M14	8,50	NAK8-20	M20	12,20
NAK-16	M16	8,50	NAK8-22	M22	12,80
NAK-18	M18	8,50	NAK8-24	M24	12,80
NAK-20	M20	8,50	NAK8-27	M27	14,30
NAK-22	M22	9,00	NAK8-30	M30	14,30
NAK-24	M24	9,00	NAK8-36	M36	14,30
NAK-27	M27	9,00			
NAK-30	M30	9,50			
NAK-33	M33	9,50			
NAK-36	M36	9,50			

## Nakrętka sześciokątna - czarna

Metric hexagon nut plain

DIN 934



Klasa 4		
INDEX	M	CENA / PRICE 1 kg [PLN]
NAKC-03	M3	14,00
NAKC-04	M4	12,00
NAKC-05	M5	9,50
NAKC-06	M6	8,50
NAKC-08	M8	8,00
NAKC-10	M10	8,00
NAKC-12	M12	8,00
NAKC-14	M14	8,00
NAKC-16	M16	8,00
NAKC-18	M18	8,00
NAKC-20	M20	8,00
NAKC-22	M22	8,50
NAKC-24	M24	8,50
NAKC-27	M27	8,50
NAKC-30	M30	9,00
NAKC-33	M33	9,00
NAKC-36	M36	9,00

## Nakrętka samokontrująca ocynkowana z wkładką poliamidową

Plain nylon insert lock nut

DIN 985



INDEX	M	CENA / PRICE 1000 szt./pcs [PLN]
NAKWK-03	M3	23,00
NAKWK-04	M4	25,00
NAKWK-05	M5	26,00
NAKWK-06	M6	36,00
NAKWK-08	M8	76,00
NAKWK-10	M10	167,00
NAKWK-12	M12	243,00
NAKWK-14	M14	373,00
NAKWK-16	M16	499,00
NAKWK-20	M20	955,00
NAKWK-24	M24	1934,00

## Nakrętka kołpakowa - ocynkowana

Hexagonal domed cap nut

DIN 1587



INDEX	M	CENA / PRICE 1000 szt./pcs [PLN]
NAKK-04	M4	90,00
NAKK-05	M5	98,00
NAKK-06	M6	110,00
NAKK-08	M8	150,00
NAKK-10	M10	273,00
NAKK-12	M12	413,00
NAKK-14	M14	658,00
NAKK-16	M16	810,00
NAKK-20	M20	2000,00

## Nakrętka kotnierzowa - ocynkowana

Hexagonal flange nut

DIN 6923



INDEX	M	CENA / PRICE 1000 szt./pcs [PLN]
NAKZ-04	M4	30,00
NAKZ-05	M5	32,10
NAKZ-06	M6	48,10
NAKZ-08	M8	100,00
NAKZ-10	M10	173,00
NAKZ-12	M12	290,00
NAKZ-16	M16	770,00

## Nakrętka motylkowa - ocynkowana

Wing nut

DIN 315



INDEX	M	CENA / PRICE 1000 szt./pcs [PLN]
NAM-03	M3	88,00
NAM-04	M4	99,00
NAM-05	M5	115,00
NAM-06	M6	120,00
NAM-08	M8	145,00
NAM-10	M10	240,00
NAM-12	M12	407,00
NAM-14	M14	2100,00
NAM-16	M16	2400,00

## Wkręt dwugwintowy

Hanger bolt

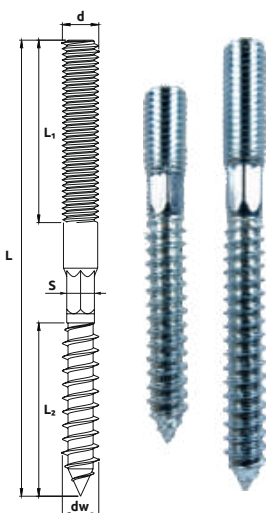

INDEX	ROZMIAR SIZE [mm]						ILOŚĆ [szt./kg] QUANTITY [pcs/kg]	ILOŚĆ [szt.] QUANTITY [pcs]		CENA / PRICE 1000 szt./pcs [PLN]
	d	L	dw	L <sub>1</sub>	L <sub>2</sub>	S				
WDT-08050	8	50	7,2	10	30	6	80	200	1200	150,72
WDT-08060	8	60	7,2	20	30	6	71	200	1200	188,53
WDT-08070	8	70	7,2	25	30	6	60	200	1200	220,00
WDT-08080	8	80	7,2	30	40	6	52	200	1200	251,39
WDT-08100	8	100	7,2	40	47	6	42	100	1000	314,22
WDT-08120	8	120	7,2	50	50	6	33	100	800	377,00
WDT-08140	8	140	7,2	50	57	6	28	100	600	439,92
WDT-08160	8	160	7,2	50	57	6	24	100	600	527,92
WDT-08180	8	180	7,2	50	57	6	21	100	400	603,39
WDT-08200	8	200	7,2	50	57	6	20	100	400	683,69
WDT-08220	8	220	7,2	50	57	6	19	100	400	764,14
WDT-08250	8	250	7,2	70	57	6	17	100	300	879,81
WDT-08280	8	280	7,2	70	57	6	15	100	300	1072,50
WDT-08300	8	300	7,2	70	57	6	12	100	300	1153,03
WDT-08350	8	350	7,2	70	57	6	7	100	300	1499,00
WDT-10060	10	60	9,2	18	30	8	40	100	1000	276,53
WDT-10080	10	80	9,2	30	40	8	35	100	800	377,06
WDT-10100	10	100	9,2	30	57	8	28	100	600	477,58
WDT-10120	10	120	9,2	50	60	8	22	100	400	603,39
WDT-10140	10	140	9,2	50	60	8	20	100	400	765,17
WDT-10160	10	160	9,2	50	60	8	15	100	400	927,39
WDT-10180	10	180	9,2	50	60	8	12	100	300	1030,67
WDT-10200	10	200	9,2	50	60	8	11	100	300	1131,19

## Wkręt do drewna z łbem sześciokątnym - ocynkowany

Coach screw

DIN 571



ø5mm

ø6mm

ø8mm

DŁUGOŚĆ LENGTH [mm]	INDEX	WAGA 1000 szt. WEIGHT 1000 pcs		CENA / PRICE		INDEX	WAGA 1000 szt. WEIGHT 1000 pcs		CENA / PRICE		INDEX	WAGA 1000 szt. WEIGHT 1000 pcs		CENA / PRICE	
		[kg]	1 kg [PLN]	1000 szt./pcs [PLN]	1 kg [PLN]		1000 szt./pcs [PLN]	[kg]	1 kg [PLN]	1000 szt./pcs [PLN]		[kg]	1 kg [PLN]	1000 szt./pcs [PLN]	
40						WKR06040	8,2	9,00	73,80		WKR08040	13,4	9,00	120,60	
50	WKR05050	7,58	11,50	75,80		WKR06050	10,1	9,00	90,90		WKR08050	15,5	9,00	139,50	
60	WKR05060	8,40	11,50	84,00		WKR06060	11,5	9,00	103,50		WKR08060	18,4	9,00	165,60	
70	WKR05070	9,22	11,50	92,00		WKR06070	13,0	9,00	117,00		WKR08070	21,6	9,00	194,40	
80	WKR05080	10,73	11,50	107,30		WKR06080	14,1	9,00	126,90		WKR08080	25,8	9,00	232,20	
90						WKR06080+	14,1	9,50	133,95		WKR08090	29,4	9,00	264,60	
100						WKR06100	17,4	9,00	156,60		WKR08100	32,2	9,00	289,80	
120						WKR06120	21,1	9,00	189,90		WKR08120	37,8	9,00	340,20	
140						WKR06140	23,1	9,00	207,90		WKR08140	43,4	9,00	390,60	
160						WKR06160	26,3	9,00	236,70		WKR08160	47,2	9,50	448,40	
180						WKR06180	29,2	9,00	262,80		WKR08180	54,2	9,50	514,90	
200						WKR06200	33,3	10,50	299,70		WKR08200	60,4	11,00	573,80	
220						WKR06220	37,1	10,50	333,90		WKR08220	65,7	11,00	624,15	
240											WKR08240	71,0	11,00	674,50	
260											WKR08260	76,6	11,00	727,70	
280											WKR08280	83,2	11,00	790,40	
300											WKR08300	84,0	12,50	798,00	
320											WKR08320	85,0	12,50	807,50	
340											WKR08340	90,1	12,50	855,30	
360											WKR08360	95,9	12,50	911,05	
380											WKR08380	101,5	12,50	964,25	
400											WKR08400	116,4	12,50	1105,80	

\* WKR06080+ - wkręt z łbem sześciokątnym i główką PZ3

ø10mm

ø12mm

DŁUGOŚĆ LENGTH [mm]	INDEX	WAGA 1000 szt. WEIGHT 1000 pcs		CENA / PRICE		INDEX	WAGA 1000 szt. WEIGHT 1000 pcs		CENA / PRICE	
		[kg]	1 kg [PLN]	1000 szt./pcs [PLN]	[kg]		1 kg [PLN]	1000 szt./pcs [PLN]		
60	WKR10060	30,0	9,00	270,00						
80	WKR10080	40,0	9,00	360,00	WKR12080	61,0	9,00	549,00		
90	WKR10090	46,4	9,00	417,50						
100	WKR10100	52,8	9,00	475,20	WKR12100	76,0	9,00	684,00		
110	WKR10110	59,2	9,00	533,20						
120	WKR10120	62,0	9,00	558,00	WKR12120	93,0	9,00	837,00		
140	WKR10140	69,0	9,00	621,00	WKR12140	104,0	9,00	936,00		
160	WKR10160	79,4	9,00	714,60	WKR12160	118,0	9,00	1062,00		
180	WKR10180	90,2	9,00	811,80	WKR12180	129,0	9,00	1161,00		
200	WKR10200	97,8	11,00	880,20	WKR12200	145,0	11,00	1305,00		
220	WKR10220	106,6	11,00	959,00	WKR12220	159,0	11,00	1431,00		
240	WKR10240	115,0	11,00	1092,50	WKR12240	174,0	11,00	1653,00		
260	WKR10260	126,7	11,00	1203,60	WKR12260	184,0	11,00	1748,00		
280	WKR10280	137,2	11,00	1303,40	WKR12280	190,0	11,00	1792,00		
300	WKR10300	145,9	12,50	1386,00	WKR12300	196,0	12,50	1862,00		
320	WKR10320	155,8	12,50	1402,20						
340	WKR10340	170,6	12,50	1620,70						
360	WKR10360	182,0	12,50	1729,00						
380	WKR10380	188,2	12,50	1787,90						
400	WKR10400	194,7	12,50	1849,60						

Śruba z łbem sześciokątnym z gwintem na całej długości  
Hexagonal head bolt fully threaded

PN-82105 / DIN 933



DŁUGOŚĆ LENGTH [mm]	M5				M6				M8			
	INDEX	WAGA 1000 szt. WEIGHT 1000 pcs [kg]	ILOŚĆ [szt./kg] QUANTITY [pcs/kg]	CENA PRICE 1 kg [PLN]	INDEX	WAGA 1000 szt. WEIGHT 1000 pcs [kg]	ILOŚĆ [szt./kg] QUANTITY [pcs/kg]	CENA PRICE 1 kg [PLN]	INDEX	WAGA 1000 szt. WEIGHT 1000 pcs [kg]	ILOŚĆ [szt./kg] QUANTITY [pcs/kg]	CENA PRICE 1 kg [PLN]
10	Ś505010	2,40	417	14,00	Ś506010	4,16	240	11,00				
12	Ś505012	2,50	400	14,00	Ś506012	4,32	231	11,00				
14	Ś505014	2,60	385	14,00	Ś506014	4,80	208	10,00	Ś508014	9,80	102	10,00
16	Ś505016	3,20	313	12,50	Ś506016	5,40	185	10,00	Ś508016	10,60	94	10,00
20	Ś505020	3,66	273	12,50	Ś506020	6,00	167	10,00	Ś508020	11,80	85	10,00
25	Ś505025	4,36	229	12,50	Ś506025	6,80	147	10,00	Ś508025	13,30	75	10,00
30	Ś505030	4,90	204	12,00	Ś506030	7,56	132	10,00	Ś508030	15,00	67	10,00
35	Ś505035	5,58	179	12,00	Ś506035	8,52	117	10,00	Ś508035	16,60	60	10,00
40	Ś505040	6,14	163	12,00	Ś506040	9,42	106	10,00	Ś508040	18,10	55	10,00
45	Ś505045	6,84	146	12,00	Ś506045	10,40	96	10,00	Ś508045	19,40	52	10,00
50	Ś505050	7,30	137	12,00	Ś506050	11,10	90	10,00	Ś508050	21,40	47	10,00
55	Ś505055	8,10	123	12,00	Ś506055	11,90	84	10,00	Ś508055	22,60	44	10,00
60	Ś505060	8,54	117	12,00	Ś506060	12,90	78	10,00	Ś508060	24,20	41	10,00
65					Ś506065	13,50	74	10,00	Ś508065	25,30	40	10,00
70					Ś506070	14,30	70	10,00	Ś508070	27,50	36	10,00
75									Ś508075	29,10	34	10,00
80					Ś506080	15,10	66	10,00	Ś508080	30,70	33	10,00
90									Ś508090	33,40	30	10,00
100									Ś508100	36,50	27	10,00
120									Ś508120	44,00	23	10,00

DŁUGOŚĆ LENGTH [mm]	M10				M12				M14			
	INDEX	WAGA 1000 szt. WEIGHT 1000 pcs [kg]	ILOŚĆ [szt./kg] QUANTITY [pcs/kg]	CENA PRICE 1 kg [PLN]	INDEX	WAGA 1000 szt. WEIGHT 1000 pcs [kg]	ILOŚĆ [szt./kg] QUANTITY [pcs/kg]	CENA PRICE 1 kg [PLN]	INDEX	WAGA 1000 szt. WEIGHT 1000 pcs [kg]	ILOŚĆ [szt./kg] QUANTITY [pcs/kg]	CENA PRICE 1 kg [PLN]
16	Ś510016	19,23	52	10,00								
20	Ś510020	21,60	46	10,00	Ś512020	31,10	32	10,00				
25	Ś510025	23,80	42	10,00	Ś512025	35,00	29	10,00				
30	Ś510030	26,60	38	10,00	Ś512030	39,10	26	10,00				
35	Ś510035	29,10	34	10,00	Ś512035	42,60	23	10,00	Ś514035	63,00	16	10,00
40	Ś510040	31,60	32	10,00	Ś512040	45,80	22	10,00	Ś514040	67,70	15	10,00
45	Ś510045	33,90	29	10,00	Ś512045	49,60	20	10,00	Ś514045	72,20	14	10,00
50	Ś510050	36,40	27	10,00	Ś512050	53,40	19	10,00	Ś514050	77,60	13	10,00
55	Ś510055	38,60	26	10,00	Ś512055	58,20	17	10,00	Ś514055	82,30	12	10,00
60	Ś510060	41,20	24	10,00	Ś512060	60,60	17	10,00	Ś514060	87,80	11	10,00
65	Ś510065	44,70	20	10,00	Ś512065	64,50	16	10,00	Ś514065	92,10	11	10,00
70	Ś510070	46,20	22	10,00	Ś512070	67,30	15	10,00	Ś514070	97,50	10	10,00
75	Ś510075	48,80	20	10,00	Ś512075	70,10	14	10,00	Ś514075	102,20	10	10,00
80	Ś510080	51,60	19	10,00	Ś512080	74,30	13	10,00	Ś514080	107,40	9	10,00
90	Ś510090	56,00	18	10,00	Ś512090	81,80	12	10,00	Ś514090	115,50	9	10,00
100	Ś510100	60,80	16	10,00	Ś512100	88,60	11	10,00	Ś514100	142,85	7	10,00
120	Ś510120	71,00	14	10,00	Ś512120	102,00	10	10,00				

DŁUGOŚĆ LENGTH [mm]	M16				M20			
	INDEX	WAGA 1000 szt. WEIGHT 1000 pcs [kg]	ILOŚĆ [szt./kg] QUANTITY [pcs/kg]	CENA PRICE 1 kg [PLN]	INDEX	WAGA 1000 szt. WEIGHT 1000 pcs [kg]	ILOŚĆ [szt./kg] QUANTITY [pcs/kg]	CENA PRICE 1 kg [PLN]
30	Ś516030	76,00	13,2	10,00				
35	Ś516035	80,00	12,5	10,00				
40	Ś516040	89,20	11,2	10,00	Ś520040	155	6,5	10,00
45	Ś516045	95,80	10,4	10,00	Ś520045	165	6,1	10,00
50	Ś516050	102,00	9,8	10,00	Ś520050	175	5,7	10,00
55	Ś516055	108,60	9,2	10,00	Ś520055	185	5,4	10,00
60	Ś516060	115,40	8,7	10,00	Ś520060	195	5,1	10,00
65	Ś516065	121,50	8,2	10,00	Ś520065	205	4,9	10,00
70	Ś516070	128,40	7,8	10,00	Ś520070	215	4,7	10,00
75	Ś516075	134,20	7,5	10,00	Ś520075	224	4,5	10,00
80	Ś516080	141,60	7,1	10,00	Ś520080	234	4,3	10,00
90	Ś516090	155,00	6,5	10,00	Ś520090	254	3,9	10,00
100	Ś516100	167,40	6,0	10,00	Ś520100	274	3,6	10,00

Śruba z łbem grzybkowym podszonym  
Round head square neck bolt partially threaded

PN-82406 / DIN 603



## M5

DŁUGOŚĆ LENGTH [mm]	INDEX	WAGA 1000 szt. WEIGHT 1000 pcs [kg]	ILOŚĆ [szt./kg] QUANTITY [pcs/kg]	CENA / PRICE	
				1 kg [PLN]	1000 szt./pcs [PLN]
16	ŚZA05016	4,50	222	11,50	54,09
20	ŚZA05020	4,70	213	11,50	56,34
25	ŚZA05025	4,90	204	11,50	58,82
30	ŚZA05030	5,27	190	11,50	63,15
35	ŚZA05035	5,87	170	11,50	70,59
40	ŚZA05040	6,47	155	11,50	77,42
45	ŚZA05045	7,06	142	11,50	84,51
50	ŚZA05050	7,66	131	11,50	94,60
55	ŚZA05055	8,26	121	11,50	99,17
60	ŚZA05060	8,86	113	11,50	106,19
65	ŚZA05065	9,46	106	11,50	113,20
70	ŚZA05070	10,10	99	11,50	123,22
75					
80	ŚZA05080	11,34	85	11,50	130,41
90					
100					
110					
120					

## M6

INDEX	WAGA 1000 szt. WEIGHT 1000 pcs [kg]	ILOŚĆ [szt./kg] QUANTITY [pcs/kg]	CENA / PRICE	
			1 kg [PLN]	1000 szt./pcs [PLN]
ŚZA06016	6,10	164	9,80	61,80
ŚZA06020	6,60	152	9,80	62,38
ŚZA06025	7,16	140	9,80	68,18
ŚZA06030	8,02	125	9,80	76,36
ŚZA06035	8,88	113	9,80	84,46
ŚZA06040	9,74	103	9,80	92,66
ŚZA06045	10,60	94	9,80	101,54
ŚZA06050	11,50	87	9,80	109,71
ŚZA06055	12,30	81	9,80	112,35
ŚZA06060	13,20	76	9,80	125,59
ŚZA06065	14,00	71	9,80	134,41
ŚZA06070	14,90	67	9,80	141,55
ŚZA06075	15,80	63	9,80	150,10
ŚZA06080	16,60	60	9,80	157,70
ŚZA06090	18,40	54	9,80	174,80
ŚZA06100	20,50	49	9,80	194,75
ŚZA06110	22,10	45	9,80	209,95
ŚZA06120	23,60	42	9,80	224,20

## M8

DŁUGOŚĆ LENGTH [mm]	INDEX	WAGA 1000 szt. WEIGHT 1000 pcs [kg]	ILOŚĆ [szt./kg] QUANTITY [pcs/kg]	CENA / PRICE	
				1 kg [PLN]	1000 szt./pcs [PLN]
12	ŚZA08012	16,67	60	13,00	216,66
16	ŚZA08016	15,15	66	11,00	166,65
20	ŚZA08020	12,40	72	9,80	124,00
25	ŚZA08025	13,90	65	9,80	139,00
30	ŚZA08030	15,40	59	9,80	146,31
35	ŚZA08035	17,00	54	9,80	161,50
40	ŚZA08040	18,50	54	9,80	175,75
45	ŚZA08045	20,00	50	9,80	190,00
50	ŚZA08050	21,60	46	9,80	205,20
55	ŚZA08055	23,20	43	9,80	220,40
60	ŚZA08060	24,80	40	9,80	235,60
65	ŚZA08065	26,30	38	9,80	249,85
70	ŚZA08070	28,00	36	9,80	226,00
75	ŚZA08075	29,60	34	9,80	281,20
80	ŚZA08080	31,20	32	9,80	296,40
90	ŚZA08090	34,40	29	9,80	326,80
100	ŚZA08100	37,60	27	9,80	357,20
110	ŚZA08110	42,20	24	9,80	400,90
120	ŚZA08120	43,40	23	9,80	412,30
130	ŚZA08130	47,50	21	9,80	451,25
140	ŚZA08140	49,90	20	9,80	474,05
150	ŚZA08150	54,80	18	9,80	520,60
160	ŚZA08160	58,80	17	9,80	558,60
180	ŚZA08180	62,50	16	9,80	595,76
200	ŚZA08200	71,45	14	9,80	678,77
220					

## M10

INDEX	WAGA 1000 szt. WEIGHT 1000 pcs [kg]	ILOŚĆ [szt./kg] QUANTITY [pcs/kg]	CENA / PRICE	
			1 kg [PLN]	1000 szt./pcs [PLN]
ŚZA10025	25,50	39,2	9,80	255,00
ŚZA10030	27,00	37,0	9,80	270,00
ŚZA10035	29,50	33,9	9,80	295,00
ŚZA10040	32,00	31,3	9,80	304,00
ŚZA10045	34,40	29,1	9,80	326,80
ŚZA10050	36,90	27,1	9,80	350,55
ŚZA10055	39,40	25,4	9,80	374,30
ŚZA10060	41,80	23,9	9,80	397,10
ŚZA10065	44,30	22,6	9,80	420,85
ŚZA10070	46,70	21,4	9,80	449,65
ŚZA10075	49,20	20,3	9,80	467,40
ŚZA10080	51,70	19,3	9,80	491,15
ŚZA10090	56,60	17,7	9,80	537,70
ŚZA10100	61,50	16,3	9,80	584,25
ŚZA10110	66,50	15,0	9,80	631,75
ŚZA10120	71,40	14,0	9,80	678,30
ŚZA10130	76,30	13,1	9,80	724,83
ŚZA10140	81,20	12,3	9,80	771,40
ŚZA10150	86,20	11,7	9,80	818,90
ŚZA10160	100,00	10,0	9,80	950,00
ŚZA10180	111,00	9,0	9,80	1054,50
ŚZA10200	125,00	8,0	9,80	1187,50
ŚZA10220	139,00	7,0	9,80	1362,50

## Śruba z tłem grzybkowym podszonym

Round head square neck bolt partially threaded

PN-82406 / DIN 603

### M12



DŁUGOŚĆ LENGTH [mm]	INDEX	WAGA 1000 szt. WEIGHT 1000 pcs [kg]	ILOŚĆ [szt./kg] QUANTITY [pcs/kg]	CENA / PRICE	
				1 kg [PLN]	1000 szt./pcs [PLN]
40	ŚZA12040	56,10	17,8	9,80	532,90
50	ŚZA12050	62,83	15,9	9,80	596,90
60	ŚZA12060	69,89	14,3	9,80	633,90
70	ŚZA12070	76,98	13,0	9,80	731,50
80	ŚZA12080	84,02	11,9	9,80	798,20
90	ŚZA12090	91,08	11,0	9,80	865,30
100	ŚZA12100	98,15	10,2	9,80	932,42
110	ŚZA12110	105,21	9,5	9,80	999,50
120	ŚZA12120	112,28	8,9	9,80	1066,70
130	ŚZA12130	119,34	8,4	9,80	1133,70
140	ŚZA12140	126,41	7,9	9,80	1200,90
150	ŚZA12150	133,47	7,5	9,80	1267,96
160	ŚZA12160	140,53	7,1	9,80	1335,00
180	ŚZA12180	154,66	6,5	9,80	1469,30
200	ŚZA12200	168,79	5,9	9,80	1654,14
220	ŚZA12220	182,93	5,3	9,80	1792,71
240	ŚZA12240	197,07	4,7	9,80	1931,29
260	ŚZA12260	211,21	4,1	9,80	2069,86

## Śruba lemieszowa / płuźna

Plow Bolt



INDEX	ROZMIAR SIZE [mm]	ILOŚĆ [kg] QUANTITY [kg]	CENA / PRICE
			1 kg [PLN]
ŚL-10030	10 x 30	20	24,85
ŚL-10035	10 x 35	20	24,85
ŚL-10040	10 x 40	20	24,85
ŚL-10045	10 x 45	20	24,85
ŚL-12030	12 x 30	20	24,85
ŚL-12035	12 x 35	20	24,85
ŚL-12040	12 x 40	20	24,85
ŚL-12045	12 x 45	20	24,85
ŚL-12050	12 x 50	20	24,85
ŚL-12060	12 x 60	20	24,85

## Konfirmat / Furniture screw



INDEX	ROZMIAR SIZE [mm]	ILOŚĆ [szt.] QUANTITY [pcs]	CENA / PRICE 1000 szt./pcs [PLN]
KONF-5040	5,0 x 40	500	64,00
KONF-6450	6,4 x 50	250	77,00
KONF-7050	7,0 x 50	250	83,00
KONF-7070	7,0 x 70	200	127,00

## Wiertło do konfirmatów / Confimat drill



INDEX	ROZMIAR SIZE [mm]	ILOŚĆ [szt.] QUANTITY [pcs]	CENA / PRICE 1000 szt./pcs [PLN]
WRKON-064	6,40	1	16,00
WRKON-070	7,00	1	16,00

## Kluczyk do konfirmatów / Key to furniture screw



INDEX	CENA / PRICE 1000 szt./pcs [PLN]
KONFKL	180,00

## Mocowanie do schodów na podłożu z betonu

Plug for fixing stair treads



INDEX	ŚR. OTWORU W STOPNICY Diameter of the hole in the tread [mm]	ŚR. OTWORU W BETONIE Diameter of the hole in concrete [mm]	ILOŚĆ [szt.] QUANTITY [pcs]	CENA / PRICE 1 szt./pcs [PLN]
TBB1	14 x 25	8 x 55	50 250	2,00

## Kółko ochronny na śruby i nakrętki

Bolt protection caps



INDEX	ROZMIAR SIZE [mm]	CENA / PRICE 1000 szt./pcs [PLN]
KOŁSN-05	SW-8	223,00
KOŁSN-06	SW-10	126,00
KOŁSN-08	SW-13	176,67
KOŁSN-10	SW-17	256,67
KOŁSN-12	SW-19	307,67
KOŁSN-14	SW-22	732,00
KOŁSN-16	SW-24	967,67
KOŁSN-20	SW-30	1987,33
KOŁSN-24	SW-36	2658,33

## Podkładka nylonowa

Nylon washer

DIN 125



INDEX	ROZMIAR SIZE [mm]	CENA / PRICE 1000 szt./pcs [PLN]
PDKN-05	M5	56,00
PDKN-06	M6	84,00
PDKN-08	M8	100,00
PDKN-10	M10	123,00
PDKN-12	M12	251,00
PDKN-14	M14	502,00
PDKN-16	M16	524,00
PDKN-20	M20	917,00
PDKN-24	M24	1600,00

## Podkładka szeroka nylonowa

Enlarged nylon washer

DIN 440



INDEX	ROZMIAR SIZE [mm]	CENA / PRICE 1000 szt./pcs [PLN]
PDK2N-05	M5	100,00
PDK2N-06	M6	128,00
PDK2N-08	M8	184,00
PDK2N-10	M10	385,00
PDK2N-12	M12	586,00
PDK2N-16	M16	1255,00

**Koszulka kołka rozporowego**

Plug for solid materials



INDEX	ROZMIAR SIZE [mm]	ILOŚĆ [szt.] QUANTITY [pcs]	CENA / PRICE za 1 blister / per 1 blister pack [PLN]
B-K-05	5 x 25	45	1,60
B-K-06	6 x 30	40	1,60
B-K-08	8 x 40	22	1,60
B-K-10	10 x 50	12	1,60
B-K-12	12 x 60	10	1,60
B-K-12/80	12 x 80	7	1,60
B-K-14	14 x 70	4	1,60
B-K-16	16 x 80	2	1,60
B-K-20	20 x 95	2	1,60

**Kołek rozporowy z wkrętem z łbem stożkowym z nacięciem krzyżowym typ POZIDRIVE**

Plug with a cross-headed wood screw type POZIDRIVE

AT-15-9042/2012



INDEX	ROZMIAR SIZE [mm]		ILOŚĆ [szt.] QUANTITY [pcs]	CENA / PRICE za 1 blister / per 1 blister pack [PLN]
B-05+	5 x 25	3,5 x 30	20	1,90
B-06+	6 x 30	3,5 x 30	15	1,90
B-06+340	6 x 30	3,5 x 40	15	1,90
B-06+350	6 x 30	3,5 x 50	15	1,90
B-06+450	6 x 30	4,0 x 50	12	1,90
B-08+	8 x 40	4,0 x 45	10	1,90
B-08+450	8 x 40	4,0 x 50	10	1,90
B-08+460	8 x 40	4,0 x 60	10	1,90
B-08+550	8 x 40	5,0 x 50	8	1,90
B-08+560	8 x 40	5,0 x 60	8	1,90
B-08+580	8 x 40	5,0 x 80	8	1,90
B-10+560	10 x 50	5,0 x 60	8	1,90
B-10+580	10 x 50	5,0 x 80	8	1,90
B-10+660	10 x 50	6,0 x 60	6	1,90
B-10+680	10 x 50	6,0 x 80	4	1,90
B-10+6100	10 x 50	6,0 x 100	3	1,90

**Kołek rozporowy z wkrętem z łbem sześciokątnym DIN 571**

Plug with a pan cap wood screw

AT-15-9042/2012



INDEX	ROZMIAR SIZE [mm]		ILOŚĆ [szt.] QUANTITY [pcs]	CENA / PRICE za 1 blister / per 1 blister pack [PLN]
B-08/550	8 x 40	5 x 50	8	1,95
B-08/560	8 x 40	5 x 60	6	1,95
B-08/580	8 x 40	5 x 80	4	1,95
B-10/660	10 x 50	6 x 60	5	1,95
B-10/680	10 x 50	6 x 80	4	1,95
B-10/100	10 x 50	6 x 100	4	1,95
B-10/120	10 x 50	6 x 120	3	1,95
B-12/60	12 x 60	8 x 60	3	1,95
B-12/80	12 x 60	8 x 80	3	1,95
B-12/100	12 x 80	8 x 100	2	1,95
B-12/120	12 x 80	8 x 120	2	1,95
B-14/80	14 x 70	10 x 80	2	1,95
B-14/100	14 x 70	10 x 100	1	1,95
B-14/120	14 x 70	10 x 120	1	1,95
B-16/100	16 x 80	10 x 100	1	1,95
B-16/120	16 x 80	10 x 120	1	1,95
B-20/120	20 x 95	12 x 120	1	1,95

## Kołek rozporowy z hakiem kątowym

Plug with hook

AT-15-9042/2012 

INDEX	ROZMIAR SIZE [mm]	ILOŚĆ [szt.] QUANTITY [pcs]	CENA / PRICE za 1 blister / per 1 blister pack [ PLN ]
B-06K	6 x 30	4,0	2,00
B-08K	8 x 40	5,0	2,00
B-10K	10 x 50	6,0	2,00
B-12K	12 x 60	8,0	2,30
B-14K	14 x 70	10,0	2,30

## Kołek rozporowy z hakiem kątowym

Plug with hook

AT-15-9042/2012 

INDEX	ROZMIAR SIZE [mm]	ILOŚĆ [szt.] QUANTITY [pcs]	CENA / PRICE za 1 blister / per 1 blister pack [ PLN ]
B-06S	6 x 30	4,0	2,20
B-08S	8 x 40	5,0	2,20
B-10S	10 x 50	6,0	2,20
B-12S	12 x 60	8,0	2,20

## Kołek rozporowy z hakiem huśtawkowym

Plug with hook

AT-15-9042/2012 

INDEX	ROZMIAR SIZE [mm]	ILOŚĆ [szt.] QUANTITY [pcs]	CENA / PRICE za 1 blister / per 1 blister pack [ PLN ]
B-12H	12 x 60	8,0	2,90

## Kołek uniwersalny z wkrętem z łbem stożkowym i nacięciem krzyżowym typu POZIDRIVE

Universal plug with screw



INDEX	ROZMIAR SIZE [mm]	ILOŚĆ [szt.] QUANTITY [pcs]	CENA / PRICE za 1 blister / per 1 blister pack [ PLN ]
B-KS-06040	6 x 40	4 x 40	2,20
B-KS-06050	6 x 40	4 x 50	2,20
B-KS-06060	6 x 40	4 x 60	2,20
B-KS-08050	8 x 50	5 x 50	2,20
B-KS-08060	8 x 50	5 x 60	2,20
B-KS-08070	8 x 50	5 x 70	2,20
B-KS-10060	10 x 60	6 x 60	2,20
B-KS-10070	10 x 60	6 x 70	2,20
B-KS-10080	10 x 60	6 x 80	2,20
B-KS-10100	10 x 60	6 x 100	2,20

## Kołek rozporowy uniwersalny z hakiem kątowym

Universal plug with hook



INDEX	ROZMIAR SIZE [mm]	ILOŚĆ [szt.] QUANTITY [pcs]	CENA / PRICE za 1 blister / per 1 blister pack [ PLN ]
B-KS-06K	6 x 30	3,5	2,80
B-KS-08K	8 x 40	4,5	2,80

## Kołek rozporowy uniwersalny z hakiem sufitowym

Universal plug with ceiling hook



INDEX	ROZMIAR SIZE [mm]	ILOŚĆ [szt.] QUANTITY [pcs]	CENA / PRICE za 1 blister / per 1 blister pack [ PLN ]
B-KS-06S	6 x 30	3,5	2,80
B-KS-08S	8 x 40	4,5	2,80



### Komplet do mocowania umywalki

Set for fixing washbasins

INDEX	ROZMIAR SIZE [mm]		ILOŚĆ [szt.] QUANTITY [pcs]	CENA / PRICE za 1 blister / per 1 blister pack [ PLN ]
B-KPU-100	12 x 60	8 x 100	2	3,50
B-KPU-120	12 x 60	8 x 120	2	3,50



### Komplet do mocowania muszli klozetowych

Set for fixing toilet bowls

INDEX	ROZMIAR SIZE [mm]		ILOŚĆ [szt.] QUANTITY [pcs]	CENA / PRICE za 1 blister / per 1 blister pack [ PLN ]
B-KPM-100	10 x 50	6 x 80	2	1,90



### Kołek do wbijania z lejkiem

Hammer drive plug with nail

AT-15-8327/2010

INDEX	ROZMIAR SIZE [mm]	ILOŚĆ [szt.] QUANTITY [pcs]	CENA / PRICE za 1 blister / per 1 blister pack [ PLN ]
B-06L-040	6 x 40	20	2,25
B-06L-060	6 x 60	20	2,50
B-06L-080	6 x 80	15	2,50
B-08L-045	8 x 45	10	2,25
B-08L-060	8 x 60	10	2,45
B-08L-080	8 x 80	10	2,78
B-08L-100	8 x 100	10	3,00
B-08L-120	8 x 120	10	3,20
B-10L-080	10 x 80	10	2,89
B-10L-100	10 x 100	5	3,28
B-10L-120	10 x 120	5	3,67



### Kołek do wbijania z kołnierzem

Hammer drive plug with nail t-type

AT-15-8327/2010

INDEX	ROZMIAR SIZE [mm]	ILOŚĆ [szt.] QUANTITY [pcs]	CENA / PRICE za 1 blister / per 1 blister pack [ PLN ]
B-06K-040	6 x 40	20	2,25
B-06K-060	6 x 60	20	2,50
B-06K-080	6 x 80	15	2,50



### Kołek stalowy typ "Molly" do płyt gipsowo-kartonowych

Hollow wall anchor

INDEX	ROZMIAR SIZE [mm]	GRUBOŚĆ PŁYTY PLATE THICKNESS [mm]	ILOŚĆ [szt.] QUANTITY [pcs]	CENA / PRICE za 1 blister / per 1 blister pack [ PLN ]
B-SM-04020	M4 x 20	2 - 6	5	3,60
B-SM-04032	M4 x 32	3 - 9	5	3,60
B-SM-04038	M4 x 38	8 - 16	5	3,60
B-SM-04046	M4 x 46	3 - 20	5	3,60
B-SM-04059	M4 x 59	31 - 38	5	3,60
B-SM-05037	M5 x 37	6 - 13	5	4,10
B-SM-05052	M5 x 52	3 - 16	5	4,10
B-SM-05065	M5 x 65	16 - 32	5	4,10
B-SM-06037	M6 x 37	6 - 13	5	4,10
B-SM-06052	M6 x 52	3 - 16	5	4,70
B-SM-06065	M6 x 65	16 - 32	5	4,70
B-SM-06080	M6 x 80	32 - 45	5	4,70
B-SM-04032K	hak kątowy	3 - 9	5	3,50
B-SM-04032S	hak sufitowy	3 - 9	5	3,50





## Kotek do zamocowań w płytach gipsowo-kartonowych "DRIVA"

Driva pin for plaster walls

INDEX	ROZMIAR SIZE [mm]	ILOŚĆ [szt.] QUANTITY [pcs]	CENA / PRICE za 1 blister / per 1 blister pack [ PLN ]
B-DRIVA-01	6 x 22	20	3,00
B-DRIVA-02	6 x 30	10	4,00



## Kotek do pustych przestrzeni

Toggle anchor for empty spaces

INDEX	ROZMIAR SIZE [mm]	ILOŚĆ [szt.] QUANTITY [pcs]	CENA / PRICE za 1 blister / per 1 blister pack [ PLN ]
B-10GL wkręt PZ-2	10 x 35	10	3,00
B-10GK hak kątowy	10 x 35	8	3,50
B-10G koszulka	10 x 35	10	2,70



## Wkręt fosfatowany samowierzący do skręcania profili typu TEX

Drywall screw

PN-EN14566 + A1:2012

INDEX	ROZMIAR SIZE [mm]	ILOŚĆ [szt.] QUANTITY [pcs]	CENA / PRICE za 1 blister / per 1 blister pack [ PLN ]
B-WS-3911	3,9 x 11	200	5,76
B-WS-3595	3,5 x 9,5	200	5,00
B-WS-3911bw	3,9 x 11	200	5,00
B-WS-3595oc	3,5 x 9,5	200	5,00
B-WS-3911oc	3,9 x 11	200	5,76
B-WS-3911pcoc	3,9 x 11	200	5,00



## Wkręt fosfatowany samowierzący z gwintem do blachy

Drywall screw

PN-EN14566 + A1:2012

INDEX	ROZMIAR SIZE [mm]	ILOŚĆ [szt.] QUANTITY [pcs]	CENA / PRICE za 1 blister / per 1 blister pack [ PLN ]
B-WS-3525	3,5 x 25	200	6,95
B-WS-3535	3,5 x 35	200	8,69
B-WS-3545	3,5 x 45	100	5,55



## Wkręt fosfatowany z gwintem do blachy do płyt G-K

Drywall screw

PN-EN14566 + A1:2012

INDEX	ROZMIAR SIZE [mm]	ILOŚĆ [szt.] QUANTITY [pcs]	CENA / PRICE za 1 blister / per 1 blister pack [ PLN ]
B-FS-3525	3,5 x 25	200	5,06
B-FS-3535	3,5 x 35	200	6,24
B-FS-3545	3,5 x 45	100	4,21
B-FS-3555	3,5 x 55	100	4,97
B-FS-4270	4,2 x 70	50	4,28



## Wkręt fosfatowany z gwintem do drewna do płyt G-K

Drywall screw

PN-EN14566 + A1:2012

INDEX	ROZMIAR SIZE [mm]	ILOŚĆ [szt.] QUANTITY [pcs]	CENA / PRICE za 1 blister / per 1 blister pack [ PLN ]
B-FT-3525	3,5 x 25	200	5,06
B-FT-3535	3,5 x 35	200	6,24
B-FT-3545	3,5 x 45	100	4,21
B-FT-3555	3,5 x 55	100	4,97
B-FT-4270	4,2 x 70	50	4,28
B-FT-4890	4,8 x 90	25	3,88
B-FT-48100	4,8 x 100	25	4,13
B-FT-48110	4,8 x 110	25	5,00
B-FT-48120	4,8 x 120	25	5,65



**Wkręt do cienkich blach, tworzyw sztucznych i drewna z tłem podkładowym**  
Wafer head phillips, sharp point screw hardened, zinc plated

INDEX	ROZMIAR SIZE [mm]	ILOŚĆ [szt.] QUANTITY [pcs]	CENA / PRICE za 1 blister / per 1 blister pack [PLN]
B-WM-4213	4,2 x 13	100	5,80
B-WM-4216	4,2 x 16	100	5,80
B-WM-4219	4,2 x 19	100	5,80
B-WM-4225	4,2 x 25	50	5,80
B-WM-4230	4,2 x 30	50	5,80
B-WM-4238	4,2 x 38	40	5,80
B-WM-4250	4,2 x 50	40	5,80
B-WM-4265	4,2 x 65	30	5,80



**Wkręt do cienkich blach, tworzyw sztucznych i drewna z tłem podkładowym, fosfatowany**  
Wafer head phillips, sharp point screw hardened, phosphated

INDEX	ROZMIAR SIZE [mm]	ILOŚĆ [szt.] QUANTITY [pcs]	CENA / PRICE za 1 blister / per 1 blister pack [PLN]
B-WMF-4213	4,2 x 13	100	5,80
B-WMF-4216	4,2 x 16	100	5,80
B-WMF-4219	4,2 x 19	100	5,80
B-WMF-4225	4,2 x 25	50	5,80
B-WMF-4230	4,2 x 30	50	5,80
B-WMF-4238	4,2 x 38	40	5,80
B-WMF-4250	4,2 x 50	40	5,80
B-WMF-4265	4,2 x 65	30	5,80



**Wkręt montażowy samowiertny, przewiercalność max. 2,25 mm**  
Wafer head phillips, self-drilling screw hardened, zinc plated

INDEX	ROZMIAR SIZE [mm]	ILOŚĆ [szt.] QUANTITY [pcs]	CENA / PRICE za 1 blister / per 1 blister pack [PLN]
B-WMS-4213	4,2 x 13	100	5,80
B-WMS-4216	4,2 x 16	100	5,80
B-WMS-4219	4,2 x 19	100	5,80
B-WMS-4225	4,2 x 25	50	5,80
B-WMS-4232	4,2 x 32	50	5,80
B-WMS-4240	4,2 x 40	40	5,80
B-WMS-4250	4,2 x 50	40	5,80
B-WMS-4265	4,2 x 65	30	5,80



**Wkręt montażowy samowiertny uniwersalny fosfatowany, przewierc. max. 2,25 mm**  
Wafer head phillips, self-drilling screw hardened, phosphated

INDEX	ROZMIAR SIZE [mm]	ILOŚĆ [szt.] QUANTITY [pcs]	CENA / PRICE za 1 blister / per 1 blister pack [PLN]
B-WMSF-4213	4,2 x 13	100	5,80
B-WMSF-4216	4,2 x 16	100	5,80
B-WMSF-4219	4,2 x 19	100	5,80
B-WMSF-4225	4,2 x 25	50	5,80
B-WMSF-4232	4,2 x 32	50	5,80
B-WMSF-4240	4,2 x 40	40	5,80
B-WMSF-4250	4,2 x 50	40	5,80
B-WMSF-4265	4,2 x 65	30	5,80



**Kotwa rozprężna do montażu sufitów podwieszanych**  
Hammer drive in anchor for suspended

AT-15-9757/2016 

INDEX	ROZMIAR SIZE [mm]	ILOŚĆ [szt.] QUANTITY [pcs]	CENA / PRICE za 1 blister / per 1 blister pack [PLN]
B-GS-06040	6,0 x 4,0	5	3,20

## Wkręt farmerski GUNNEBO do mocowania blach do konstrukcji drewnianych z aluminiową podkładką EPDM

Self drilling screw with EPDM washer



INDEX	ROZMIAR SIZE [mm]	KOŁOR COLOR	ILOŚĆ [szt.] QUANTITY [pcs]	CENA / PRICE za 1 blister / per 1 blister pack [PLN]
B-OD-20 oc	4,8 x 20	ocynk / zinc	50	9,50
B-OD-20 3009	4,8 x 20	czerwony / red	50	10,50
B-OD-20 8004	4,8 x 20	ceglasty / brick red	50	10,50
B-OD-20 8017	4,8 x 20	brązowy / brown	50	10,50
B-OD-35 oc	4,8 x 35	ocynk / zinc	50	9,50
B-OD-35 3009	4,8 x 35	czerwony / red	50	10,50
B-OD-35 8004	4,8 x 35	ceglasty / brick red	50	10,50
B-OD-35 8017	4,8 x 35	brązowy / brown	50	10,50
B-OD-60 oc	4,8 x 60	ocynk / zinc	25	9,50
B-OD-60 3009	4,8 x 60	czerwony / red	25	10,50
B-OD-60 8004	4,8 x 60	ceglasty / brick red	25	10,50
B-OD-60 8017	4,8 x 60	brązowy / brown	25	10,50

## Wkręt samowiertny do mocowania blach do konstrukcji stalowych bez podkładki

Self drilling screw



INDEX	ROZMIAR SIZE [mm]	MAKSYMALNA PRZEWIERCALNOŚĆ DRILLING CAPACITY [mm]	ILOŚĆ [szt.] QUANTITY [pcs]	CENA / PRICE za 1 blister / per 1 blister pack [PLN]
B-OC-4813	4,8 x 13	3,0	50	5,80
B-OC-4816	4,8 x 16	3,0	50	5,80
B-OC-4819	4,8 x 19	3,0	50	5,80
B-OC-4822	4,8 x 22	3,0	50	5,80
B-OC-4825	4,8 x 25	3,0	50	5,80
B-OC-4832	4,8 x 32	3,0	45	5,80
B-OC-4835	4,8 x 35	3,0	45	5,80
B-OC-4838	4,8 x 38	3,0	40	5,80
B-OC-5519	5,5 x 19	5,0	40	5,80
B-OC-5525	5,5 x 25	5,0	30	5,80
B-OC-5575	5,5 x 75	5,0	20	5,80
B-OC-6332	6,3 x 32	6,0	25	5,80
B-OC-6363	6,3 x 63	6,0	15	5,80

## Wkręt samowiertny do mocowania blach do konstrukcji stalowych z podkładką EPDM

Self drilling screw with EPDM washer



INDEX	ROZMIAR SIZE [mm]	MAKSYMALNA PRZEWIERCALNOŚĆ DRILLING CAPACITY [mm]	ILOŚĆ [szt.] QUANTITY [pcs]	CENA / PRICE za 1 blister / per 1 blister pack [PLN]
B-OCG-4816	4,8 x 16	3,0	60	10,00
B-OCG-4819	4,8 x 19	3,0	60	10,00
B-OCG-4822	4,8 x 22	3,0	60	10,00
B-OCG-4825	4,8 x 25	3,0	60	10,00
B-OCG-4832	4,8 x 32	3,0	50	10,00
B-OCG-4835	4,8 x 35	3,0	50	10,00
B-OCG-4845	4,8 x 45	3,0	50	10,00
B-OCG-4855	4,8 x 55	3,0	50	10,00
B-OCG-5519	5,5 x 19	5,0	60	10,00
B-OCG-5525	5,5 x 25	5,0	60	10,00
B-OCG-5532	5,5 x 32	5,0	50	10,00
B-OCG-5538	5,5 x 38	5,0	50	10,00
B-OCG-5550	5,5 x 50	5,0	40	10,00

**Wkręt hartowany do drewna, płyt wiórowych i PCV**  
Self-drilling roofing screw with EPDM washer



INDEX	ROZMIAR SIZE [mm]	ILOŚĆ [szt.] QUANTITY [pcs]	CENA / PRICE za 1 blister / per 1 blister pack [PLN]
B-UC-2512	2,5 x 12	100	2,90
B-UC-2516	2,5 x 16	100	2,90
B-UC-2520	2,5 x 20	100	2,90
B-UC-3012	3,0 x 12	100	2,90
B-UC-3016	3,0 x 16	100	2,90
B-UC-3020	3,0 x 20	100	2,90
B-UC-3025	3,0 x 25	100	2,90
B-UC-3030	3,0 x 30	90	2,90
B-UC-3035	3,0 x 35	80	2,90
B-UC-3040	3,0 x 40	50	2,90
B-UC-3512	3,5 x 12	100	2,90
B-UC-3516	3,5 x 16	90	2,90
B-UC-3520	3,5 x 20	80	2,90
B-UC-3525	3,5 x 25	80	2,90
B-UC-3530	3,5 x 30	70	2,90
B-UC-3535	3,5 x 35	60	2,90
B-UC-3540	3,5 x 40	40	2,90
B-UC-3545	3,5 x 45	50	2,90
B-UC-3550	3,5 x 50	50	2,90
B-UC-4012	4,0 x 12	90	2,90
B-UC-4016	4,0 x 16	80	2,90
B-UC-4020	4,0 x 20	70	2,90
B-UC-4025	4,0 x 25	60	2,90
B-UC-4030	4,0 x 30	50	2,90
B-UC-4035	4,0 x 35	50	2,90
B-UC-4040	4,0 x 40	50	2,90
B-UC-4045	4,0 x 45	50	2,90
B-UC-4050	4,0 x 50	35	2,90
B-UC-4060	4,0 x 60	30	2,90
B-UC-4070	4,0 x 70	25	2,90
B-UC-4525	4,5 x 25	50	2,90
B-UC-4530	4,5 x 30	40	2,90
B-UC-4535	4,5 x 35	40	2,90
B-UC-4540	4,5 x 40	40	2,90
B-UC-4545	4,5 x 45	40	2,90
B-UC-4550	4,5 x 50	30	2,90
B-UC-4560	4,5 x 60	20	2,90
B-UC-4570	4,5 x 70	20	2,90
B-UC-4580	4,5 x 80	15	2,90
B-UC-5020	5,0 x 20	50	2,90
B-UC-5025	5,0 x 25	40	2,90
B-UC-5030	5,0 x 30	40	2,90
B-UC-5035	5,0 x 35	35	2,90
B-UC-5040	5,0 x 40	30	2,90
B-UC-5045	5,0 x 45	30	2,90
B-UC-5050	5,0 x 50	25	2,90
B-UC-5060	5,0 x 60	20	2,90
B-UC-5070	5,0 x 70	20	2,90
B-UC-5080	5,0 x 80	15	2,90
B-UC-5090	5,0 x 90	15	2,90
B-UC-5100	5,0 x 100	10	2,90
B-UC-5110	5,0 x 110	10	2,90
B-UC-5120	5,0 x 120	8	2,90

## Wkręt hartowany do drewna, płyt wiórowych i PCV

Self-drilling roofing screw with EPDM washer



INDEX	ROZMIAR SIZE [mm]	ILOŚĆ [szt.] QUANTITY [pcs]	CENA / PRICE za 1 blister / per 1 blister pack [PLN]
B-UC-6030	6,0 x 30	25	2,90
B-UC-6040	6,0 x 40	20	2,90
B-UC-6045	6,0 x 45	20	2,90
B-UC-6050	6,0 x 50	15	2,90
B-UC-6060	6,0 x 60	15	2,90
B-UC-6070	6,0 x 70	10	2,90
B-UC-6080	6,0 x 80	10	2,90
B-UC-6090	6,0 x 90	10	2,90
B-UC-6100	6,0 x 100	8	2,90
B-UC-6110	6,0 x 110	8	2,90
B-UC-6120	6,0 x 120	5	2,90

## Kotwa rozprężna do średnich obciążeń

Sleeve anchor

AT-15-8309/2016



INDEX	ROZMIAR SIZE [mm]	ILOŚĆ [szt.] QUANTITY [pcs]	CENA / PRICE za 1 blister / per 1 blister pack [PLN]
B-KT-08040	M8 x 40	5	4,80
B-KT-08065	M8 x 65	5	4,80
B-KT-08085	M8 x 85	5	4,80
B-KT-10040	M10 x 40	5	5,60
B-KT-10050	M10 x 50	5	5,60
B-KT-10080	M10 x 80	5	6,60
B-KTS-08050	M8 x 50	5	6,60

## Tuleja stalowa

Drop in anchor

AT-15-8302/2016



INDEX	ROZMIAR SIZE [mm]	ILOŚĆ [szt.] QUANTITY [pcs]	CENA / PRICE za 1 blister / per 1 blister pack [PLN]
B-TS-06	8 x 25	10	4,80
B-TS-08	10 x 30	8	4,80
B-TS-10	12 x 40	6	4,80
B-TS-12	15 x 50	4	5,50
B-TS-16	20 x 65	2	5,50

## Tuleja mosiężna

Brass anchor

AT-15-8302/2016



INDEX	ROZMIAR SIZE [mm]	ILOŚĆ [szt.] QUANTITY [pcs]	CENA / PRICE za 1 blister / per 1 blister pack [PLN]
B-TM-05	7 x 20	8	4,80
B-TM-06	8 x 25	6	4,80
B-TM-08	10 x 30	6	4,80
B-TM-10	12 x 40	3	4,80
B-TM-12	15 x 40	2	4,80
B-TM-16	20 x 44	1	4,80

## Metalowy kotek rozporowy do gazobetonu

Metal universal plug

AT-15-9757/2016



INDEX	ROZMIAR SIZE [mm]	ILOŚĆ [szt.] QUANTITY [pcs]	CENA / PRICE za 1 blister / per 1 blister pack [PLN]
B-KRG-0632	6 x 32	6	3,20
B-KRG-0838	8 x 38	6	3,20
B-KRG-0860	8 x 60	4	3,20
B-KRG-1060	10 x 60	4	3,20

**Nit zrywalny Al/Fe**

Open type blind rivet with dome head



INDEX	ROZMIAR SIZE [mm]	ILOŚĆ [szt.] QUANTITY [pcs]	CENA / PRICE za 1 blister / per 1 blister pack [PLN]
B-NIT 306	3 x 6	30	2,20
B-NIT 308	3 x 8	30	2,20
B-NIT 310	3 x 10	25	2,20
B-NIT 312	3 x 12	25	2,20
B-NIT 406	4 x 6	25	2,20
B-NIT-408	4 x 8	20	2,20
B-NIT-410	4 x 10	20	2,20
B-NIT-412	4 x 12	20	2,20
B-NIT-414	4 x 14	15	2,20
B-NIT-416	4 x 16	15	2,20
B-NIT-418	4 x 18	15	2,20
B-NIT-420	4 x 20	12	2,20
B-NIT-506	5 x 6	12	2,20
B-NIT-508	5 x 8	12	2,20
B-NIT-510	5 x 10	12	2,20
B-NIT-512	5 x 12	10	2,20
B-NIT-514	5 x 14	10	2,20
B-NIT-516	5 x 16	10	2,20
B-NIT-518	5 x 18	10	2,20
B-NIT-520	5 x 20	10	2,20
B-NIT-522	5 x 22	8	2,20
B-NIT-524	5 x 24	8	2,20
B-NIT-526	5 x 26	8	2,20
B-NIT-610	6 x 10	8	2,20
B-NIT-612	6 x 12	8	2,20
B-NIT-614	6 x 14	8	2,20
B-NIT-616	6 x 16	6	2,20
B-NIT-618	6 x 18	6	2,20
B-NIT-620	6 x 20	6	2,20

**Wkręt dwugwintowy**

Hanger bolt



INDEX	ROZMIAR SIZE [mm]	ILOŚĆ [szt.] QUANTITY [pcs]	CENA / PRICE za 1 blister / per 1 blister pack [PLN]
B-WD-08050	8 x 50	5	3,00
B-WD-08060	8 x 60	5	3,00
B-WD-08070	8 x 70	4	3,00
B-WD-08100	8 x 100	4	3,00
B-WD-08120	8 x 120	4	3,00
B-WD-10060	10 x 60	5	3,00
B-WD-10080	10 x 80	4	3,00
B-WD-10100	10 x 100	4	3,00
B-WD-10120	10 x 120	4	3,00

**Zacisk do lin, ocynkowany**

Wire rope clip



INDEX	ŚREDNICA DIAMETER [mm]	ILOŚĆ [szt.] QUANTITY [pcs]	CENA / PRICE za 1 blister / per 1 blister pack [PLN]
B-ZAC-03	3,0	5	3,00
B-ZAC-05	5,0	4	3,00
B-ZAC-06	6,0	3	3,00
B-ZAC-08	8,0	2	3,00
B-ZAC-10	10,0	1	3,00
B-ZAC-12/13	12,0/13,0	1	3,00

## Podkładka sprężynowa, ocynkowana

Spring washer

PN-82008  
DIN 127B



INDEX	ROZMIAR SIZE [mm]	ŚREDNICA OTWORU HOLE DIAMETE [mm]	ILOŚĆ [szt.] QUANTITY [pcs]	CENA / PRICE za 1 blister / per 1 blister pack [ PLN ]
B-PODS-03	M3	3,1	100	1,95
B-PODS-04	M4	4,1	80	1,95
B-PODS-05	M5	5,1	50	1,95
B-PODS-06	M6	6,1	25	1,95
B-PODS-08	M8	8,2	15	1,95
B-PODS-10	M10	10,2	10	1,95
B-PODS-12	M12	12,2	10	1,95
B-PODS-14	M14	14,2	10	1,95
B-PODS-16	M16	16,3	10	2,20
B-PODS-20	M20	20,5	5	2,20

## Podkładka okrągła zgrubna powiększona, ocynkowana

Round washer

PN-82030  
DIN 9021



INDEX	ROZMIAR SIZE [mm]	ŚREDNICA OTWORU HOLE DIAMETE [mm]	ILOŚĆ [szt.] QUANTITY [pcs]	CENA / PRICE za 1 blister / per 1 blister pack [ PLN ]
B-POP-3004	M4	4,2	60	1,95
B-POP-3005	M5	5,5	40	1,95
B-POP-3006	M6	6,5	20	1,95
B-POP-3008	M8	8,5	10	1,95
B-POP-3010	M10	10,5	6	1,95
B-POP-3012	M12	13,0	4	1,95
B-POP-3014	M14	15,0	3	1,95
B-POP-3016	M16	17,0	2	2,20
B-POP-3020	M20	21,0	1	2,20

## Podkładka okrągła poszerzona, ocynkowana

Round washer

PN-82019  
DIN 440R



INDEX	ROZMIAR SIZE [mm]	ŚREDNICA OTWORU HOLE DIAMETE [mm]	ILOŚĆ [szt.] QUANTITY [pcs]	CENA / PRICE za 1 blister / per 1 blister pack [ PLN ]
B-POP-1905	M5	5,5	20	1,95
B-POP-1906	M6	6,6	10	1,95
B-POP-1908	M8	9,0	5	1,95
B-POP-1910	M10	11,0	5	1,95
B-POP-1912	M12	14,0	5	1,95
B-POP-1914	M14	16,0	4	1,95
B-POP-1916	M16	18,0	2	2,20

## Podkładka okrągła zgrubna, ocynkowana

Round washer

PN-82005  
DIN 125



INDEX	ROZMIAR SIZE [mm]	ŚREDNICA OTWORU HOLE DIAMETE [mm]	ILOŚĆ [szt.] QUANTITY [pcs]	CENA / PRICE za 1 blister / per 1 blister pack [ PLN ]
B-POD-03	M3	3,2	160	1,95
B-POD-04	M4	4,3	120	1,95
B-POD-05	M5	5,3	80	1,95
B-POD-06	M6	6,4	40	1,95
B-POD-08	M8	8,4	20	1,95
B-POD-10	M10	10,5	10	1,95
B-POD-12	M12	13,0	10	1,95
B-POD-14	M14	15,0	8	1,95
B-POD-16	M16	17,0	5	2,20
B-POD-20	M20	21,0	3	2,20

**Nakrętka sześciokątna, ocynkowana**  
Metric hexagon nut

**PN-82144**  
**DIN 934**



INDEX	ROZMIAR SIZE [mm]	ILOŚĆ [szt.] QUANTITY [pcs]	CENA / PRICE za 1 blister / per 1 blister pack [PLN]
B-NAK-03	M3	40	1,95
B-NAK-04	M4	35	1,95
B-NAK-05	M5	25	1,95
B-NAK-06	M6	20	1,95
B-NAK-08	M8	10	1,95
B-NAK-10	M10	5	1,95
B-NAK-12	M12	4	1,95
B-NAK-14	M14	3	1,95
B-NAK-16	M16	3	1,95
B-NAK-20	M20	2	2,20

**Nakrętka samokontrująca z wkładką, ocynkowana**  
Plain nylon insert lock nut

**PN-82175**  
**DIN 985**



INDEX	ROZMIAR SIZE [mm]	ILOŚĆ [szt.] QUANTITY [pcs]	CENA / PRICE za 1 blister / per 1 blister pack [PLN]
B-NAKWK-04	M4	10	1,95
B-NAKWK-05	M5	10	1,95
B-NAKWK-06	M6	10	1,95
B-NAKWK-08	M8	6	1,95
B-NAKWK-10	M10	4	1,95
B-NAKWK-12	M12	2	1,95
B-NAKWK-14	M14	2	1,95
B-NAKWK-16	M16	2	1,95
B-NAKWK-20	M20	2	2,20

**Nakrętka kołpakowa, ocynkowana**  
Hexagonal domed cap nut

**PN-82181**  
**DIN 1587**



INDEX	ROZMIAR SIZE [mm]	ILOŚĆ [szt.] QUANTITY [pcs]	CENA / PRICE za 1 blister / per 1 blister pack [PLN]
B-NAKK-05	M5	6	1,95
B-NAKK-06	M6	6	1,95
B-NAKK-08	M8	4	1,95
B-NAKK-10	M10	2	1,95
B-NAKK-12	M12	2	1,95
B-NAKK-14	M14	2	2,20
B-NAKK-16	M16	2	2,80
B-NAKK-20	M20	2	4,20

**Nakrętka motylkowa, ocynkowana**  
Wing nut

**DIN 315**



INDEX	ROZMIAR SIZE [mm]	ILOŚĆ [szt.] QUANTITY [pcs]	CENA / PRICE za 1 blister / per 1 blister pack [PLN]
B-NAM-03	M3	10	1,95
B-NAM-04	M4	8	1,95
B-NAM-05	M5	6	1,95
B-NAM-06	M6	4	1,95
B-NAM-08	M8	3	1,95
B-NAM-10	M10	2	1,95
B-NAM-12	M12	2	1,95

**Nakrętka złączna**  
Coupling nut

**DIN 6334**



INDEX	ROZMIAR SIZE [mm]	ILOŚĆ [szt.] QUANTITY [pcs]	CENA / PRICE za 1 blister / per 1 blister pack [PLN]
B-NZ-06	M6 x 18	10	5,00
B-NZ-08	M8 x 24	8	5,00
B-NZ-10	M10 x 30	6	5,00
B-NZ-12	M12 x 36	4	5,00
B-NZ-14	M14 x 42	2	5,00
B-NZ-16	M16 x 48	2	5,00

## Kotek uniwersalny DUOPOWER

Universal plug with a screw

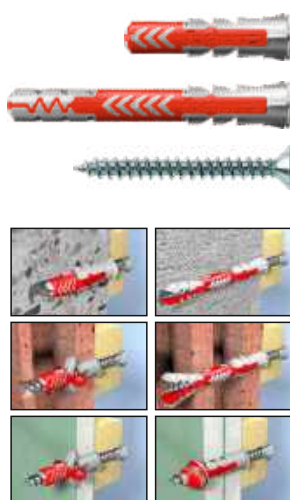

INDEX	ROZMIAR SIZE [mm]		ILOŚĆ [szt.] QUANTITY [pcs]		CENA / PRICE 1000 szt./pcs [PLN]
FIS-DUK05025	5 x 25	-	100	4000	149,10
FIS-DUK06030	6 x 30	-	100	5000	227,70
FIS-DUK06050	6 x 50	-	100	2500	436,10
FIS-DUK08040	8 x 40	-	100	2500	327,30
FIS-DUK08065	8 x 65	-	50	1200	507,50
FIS-DUK10050	10 x 50	-	50	1200	633,60
FIS-DUK10080	10 x 80	-	25	500	970,20
FIS-DUK12060	12 x 60	-	25	600	934,30
FIS-DUK14070	14 x 70	-	20	400	1735,20
FIS-DUO05025s	5 x 25	4.0 x 35	50	2500	694,10
FIS-DUO06030s	6 x 30	4.5 x 40	50	2500	721,10
FIS-DUO06050s	6 x 50	4.5 x 70	50	1200	1379,30
FIS-DUO08040s	8 x 40	5.0 x 60	50	1200	1050,00
FIS-DUO08065s	8 x 65	5.0 x 80	25	600	1628,40
FIS-DUO10050s	10 x 50	7.0 x 70	25	250	1584,10
FIS-DUO10080s	10 x 80	7.0 x 107	10	240	3470,50
FIS-DUO12060s	12 x 60	8.0 x 80	10	250	3221,40
FIS-DUO14070s	14 x 70	10.0 x 95	8	80	5970,80
<b>DUOPOWER BOX</b>	<b>DUOPOWER:</b> 5 x 25 - 15 szt., 6 x 30 - 70 szt., 8x40 - 40 szt., 10x50 - 15 szt. <b>WKREŃ:</b> PZ 4,0x35 - 15 szt., SZ 4,5x40 ZPF - 70 szt., SZ 5,0x60 ZPF - 40 szt., HEX 7x69 - 15 szt.				<b>140,00</b> (opak./box)

## Kotek DUOTEC do płyt GK

Nylon toggle fischer DUOTEC

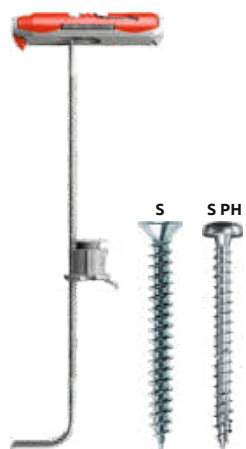

INDEX	ROZMIAR SIZE [mm]		ILOŚĆ [szt.] QUANTITY [pcs]	CENA / PRICE 1000 szt./pcs [PLN]
FIS-DUOT10	10.0	4.5 - 5.0	50	3025,50
FIS-DUOT10S	10.0	5.0	25	3203,20
FIS-DUOT10SPH	10.0	5.0	25	3559,60

MONTAŻ W PŁYTACH Z PUSTYMI PRZESTRZENIAM:

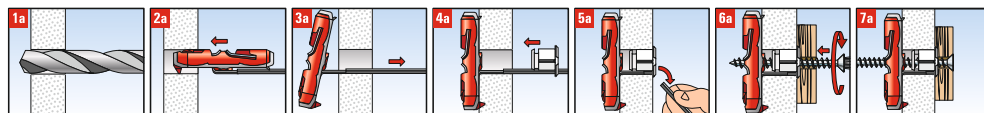

MONTAŻ W PEŁNYM MATERIALE:

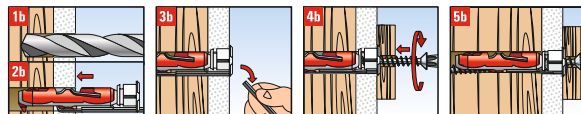

## Kotek uniwersalny Fischer SX













Universal plug with screw



INDEX	ROZMIAR SIZE [mm]	ILOŚĆ [szt.] QUANTITY [pcs]		CENA / PRICE 1000 szt./pcs [PLN]
FIS-SX 4x20	2.0-3.0	200		148,80
FIS-SX 5x25	3.0-4.0	100		169,40
FIS-SX 6x30	4.0-5.0	100		247,80
FIS-SX 8x40	4.5-6.0	100		351,90
FIS-SX 10x50	6.0-8.0	50		686,00
FIS-SX 12x60	8.0-10.0	25		1012,20
FIS-SX 14x70	10.0-12.0	20		1924,10
FIS-SX 16x80	12(1/2")	10		2732,20
FIS-SX 6x50	4.0-5.0	100		482,20
FIS-SX 8x65	4.5-6.0	50		592,50
FIS-SX 10x80	6.0-8.0	25		1056,90
FIS-SX-S 6x30	4.5 x 40	50		772,30
FIS-SX-S 8x40	5.0 x 60	50		1124,30





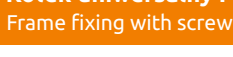





## Kotek uniwersalny Fischer UX

Universal plug with screw

INDEX	ROZMIAR SIZE [mm]		ILOŚĆ [szt.] QUANTITY [pcs]		CENA / PRICE 1000 szt./pcs [PLN]
					
 FIS-UX5	5 x 30	-	100	5000	317,10
FIS-UX6	6 x 35	-	100	5000	381,00
FIS-UX8	8 x 50	-	100	2000	520,00
FIS-UX10	10 x 60	-	50	1000	956,10
FIS-UX12	12 x 70	-	25	600	1529,20
FIS-UX14	14 x 75	-	20	400	2455,40
<b>FIS-UX 6x35R S/20</b>					
 FIS-UX 6x35R S/20	6 x 35	4.5 x 60	25	625	1493,70
 FIS-UX 6x50R S/20	6 x 50	4.5 x 70	25	625	1905,70
 FIS-UX 8x50R S/15	8 x 50	5.0 x 70	25	600	2013,40
 FIS-UX 8x50R S/25	8 x 50	5.0 x 80	25	600	2452,80
 FIS-UX 10x60R S/20	10 x 60	6.0 x 85	10	250	4697,50
<b>FIS-UX 6x35 WH</b>					
 FIS-UX 6x35 WH	6 x 35	4.5 x 51	25	625	7462,00
 FIS-UX 8x50 WH	8 x 50	5.5 x 70	25	625	7504,60
<b>FIS-UX 6x35 RH</b>					
 FIS-UX 6x35 RH	6 x 35	4.5 x 67	25	625	7397,30
 FIS-UX 8x50 RH	8 x 50	5.5 x 87	25	500	7958,60

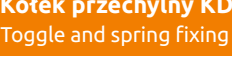

## Kotek uniwersalny FU

Frame fixing with screw

INDEX	ROZMIAR SIZE [mm]		ILOŚĆ [szt.] QUANTITY [pcs]		CENA / PRICE 1000 szt./pcs [PLN]
					
 FIS-FU 6x35	6 x 35	-	50	2500	801,60
FIS-FU 6x45	6 x 45	-	50	2500	868,40
FIS-FU 8x40	8 x 40	-	50	2500	933,00
FIS-FU 8x50	8 x 50	-	50	1250	968,00
FIS-FU 10x60	10 x 60	-	25	625	1759,70
<b>FIS-FU 6x35 S/20</b>					
 FIS-FU 6x35 S/20	6 x 35	3.5 x 55	25	1250	2211,90
 FIS-FU 8x50 S/25	8 x 50	4.5 x 75	25	600	3454,90
 FIS-FU 10x60 S/25	10 x 60	6.5 x 85	10	250	5423,50
 FIS-FU 6x45 S/10	6 x 45	3.5 x 55	25	1250	2049,10
 FIS-FU 6x35 S/10	6 x 35	3.5 x 45	25	1250	1472,40
 FIS-FU 8x50 S/10	8 x 50	4.5 x 60	25	500	2028,30
 FIS-FU 10x60 S/20	10 x 60	6.5 x 80	10	250	3876,80

## Kotek przechyłny KD

Toggle and spring fixing KD

INDEX	ROZMIAR SIZE [mm]	ILOŚĆ [szt.] QUANTITY [pcs]		CENA / PRICE 1000 szt./pcs [PLN]
				
 FIS-KD4	M4 x 100	25		4922,90
FIS-KD5	M5 x 100	25		5628,70
FIS-KD6	M6 x 100	25		5630,20
FIS-KD8	M8 x 100	20		7382,70

## Oznacznik montażowy do centrowania otworów stopni schodowych

Installation aid



INDEX	ILOŚĆ [szt.] QUANTITY [pcs]		CENA / PRICE 1000 szt./pcs [PLN]
FIS-TBZ2	10	100	4717,10

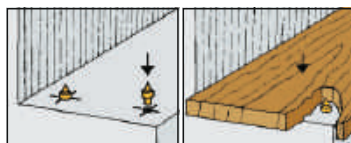

## Mocowanie do schodów w konstrukcji stalowej

Plug for fixing stair treads



INDEX	ŚR. OTWORU W STOPNICY Diameter of the hole in the tread [mm]	ROZMIAR SIZE [mm]	ILOŚĆ [szt.] QUANTITY [pcs]		CENA / PRICE 1000 szt./pcs [PLN]
FIS-TB	14 x 25	5 x 40	50	500	6748,20

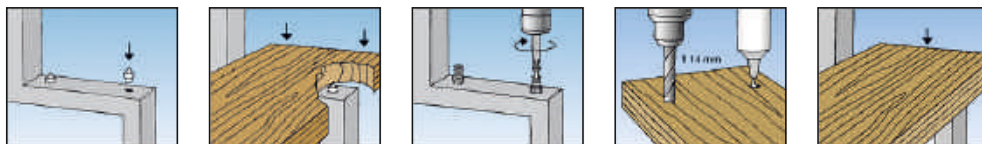

## Mocowanie do schodów na podłożu z betonu

Plug for fixing stair treads



INDEX	ŚR. OTWORU W STOPNICY Diameter of the hole in the tread [mm]	ŚR. OTWORU W BETONIE Diameter of the hole in concrete [mm]	ILOŚĆ [szt.] QUANTITY [pcs]		CENA / PRICE 1000 szt./pcs [PLN]
FIS-TBB	14 x 25	8 x 55	50	250	6641,90

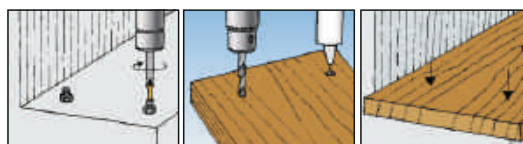

## Odbijnik drzwiowy TS

Door bumper



INDEX	ROZMIAR SIZE [mm]	KOLOR COLOR	ILOŚĆ [szt.] QUANTITY [pcs]		CENA / PRICE 10 szt./pcs [PLN]
FIS-TS 8 BG	8 x 60	beżowy / beige	10	100	129,60
FIS-TS 8 BR	8 x 60	brązowy / brown	10	100	129,60
FIS-TS 8 G	8 x 60	srebrny / silver	10	100	129,60
FIS-TS 8 S	8 x 60	czarny / black	10	100	130,90
FIS-ODTS 8 W	8 x 60	biały / white	10	100	130,90



TS-SORT	8 x 60	zestaw 25 szt. (5 kolorów) set of 25 items (5 colors)	1	4	374,90
---------	--------	--	---	---	--------

## Kotek PD do płyt gipsowo-kartonowych, wiórowych, cementowo-piślniowych

Board fixing

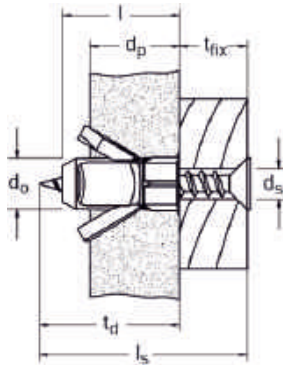

INDEX	d <sub>o</sub> [mm]	t <sub>d</sub> [mm]	d <sub>p</sub> [mm]	l [mm]	d <sub>s</sub> x l <sub>s</sub> [mm]	ILOŚĆ [szt.] QUANTITY [pcs]		CENA / PRICE 1000 szt./pcs [PLN]
<b>FIS-PD8</b>	8	31	6	29	4	100	5000	808,90
<b>FIS-PD10</b>	10	30	7	28	5	100	2500	1065,70
<b>FIS-PD12</b>	12	28	9	27	6	50	2500	1282,00

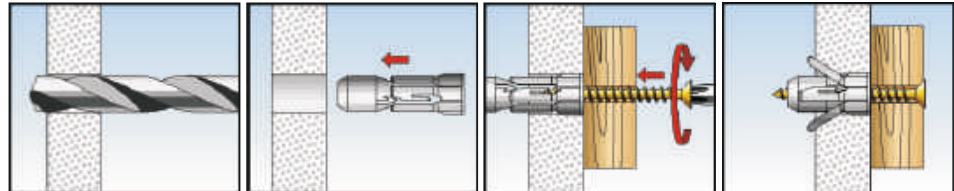

## Kotek uniwersalny ramowy FUR

Frame fixing with hexagonal head screw

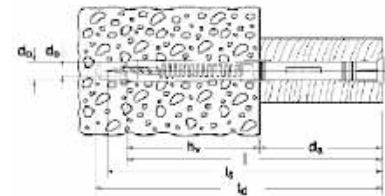
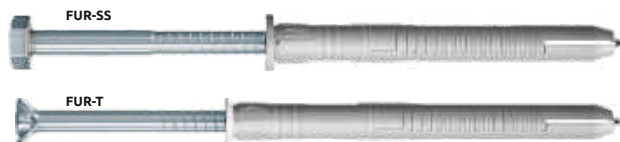

INDEX	d <sub>o</sub> [mm]	t <sub>d</sub> [mm]	Min h <sub>v</sub> [mm]	l [mm]	Max d <sub>a</sub> [mm]	d <sub>s</sub> x l <sub>s</sub> [mm]	ILOŚĆ [szt.] QUANTITY [pcs]		CENA / PRICE 1000 szt./pcs [PLN]
<b>FIS-FUR 8x80SS</b>	8	90	70	80	10	6 x 85	50	500	3580,60
<b>FIS-FUR 8x100SS</b>	8	110	70	100	30	6 x 105	50	500	4292,00
<b>FIS-FUR 8x120SS</b>	8	130	70	120	50	6 x 125	50	250	4774,10
<b>FIS-FUR 10x80SS</b>	10	90	70	80	10	7 x 85	50	250	4161,60
<b>FIS-FUR 10x100SS</b>	10	110	70	100	30	7 x 105	50	250	4560,30
<b>FIS-FUR 10x115SS</b>	10	125	70	115	45	7 x 120	50	250	5044,20
<b>FIS-FUR 10x135SS</b>	10	145	70	135	65	7 x 140	50	250	6372,00
<b>FIS-FUR 10x160SS</b>	10	170	70	160	90	7 x 165	50	250	8738,70
<b>FIS-FUR 10x185SS</b>	10	195	70	185	115	7 x 190	50	50	11 922,10
<b>FIS-FUR 10x200SS</b>	10	210	70	200	130	7 x 205	50	50	14 146,20
<b>FIS-FUR 10x230SS</b>	10	240	70	230	160	7 x 235	50	50	16 302,10
<b>FIS-FUR 8x80T</b>	8	90	70	80	10	6 x 85	50	500	3498,60
<b>FIS-FUR 8x100T</b>	8	110	70	100	30	6 x 105	50	500	4234,20
<b>FIS-FUR 8x120T</b>	8	130	70	120	50	6 x 125	50	250	4584,40
<b>FIS-FUR 10x80T</b>	10	90	70	80	10	7 x 85	50	250	4206,00
<b>FIS-FUR 10x100T</b>	10	110	70	100	30	7 x 105	50	250	4590,50
<b>FIS-FUR 10x115T</b>	10	125	70	115	45	7 x 120	50	250	5139,60
<b>FIS-FUR 10x135T</b>	10	145	70	135	65	7 x 140	50	250	6283,00
<b>FIS-FUR 10x160T</b>	10	170	70	160	90	7 x 165	50	250	8678,90
<b>FIS-FUR 10x185T</b>	10	195	70	185	115	7 x 190	50	50	11 560,90
<b>FIS-FUR 10x200T</b>	10	210	70	200	130	7 x 205	50	50	14 518,00
<b>FIS-FUR 10x230T</b>	10	240	70	230	160	7 x 235	50	50	16 484,90

Zastosowanie do cegły dziurawki, kratówki i pełnej, pustaków, gazobetonu, betonu lekkiego, betonu, płyt gipsowych oraz innych materiałów budowlanych o niskiej wytrzymałości na ściskanie.

Application for perforated, checkered and solid bricks, hollow bricks, aerated concrete, light concrete, concrete, gypsum boards and other building materials with low compressive strength.

## System poziomowania płytek - zestaw startowy

Tile leveling system - starter pack

Produkt dostępny w 2021 r.  
Product available in 2021

INDEX	NAZWA NAME	GRUBOŚĆ FUGI SIZE [mm]	ILOŚĆ [szt.] QUANTITY [pcs]	CENA / PRICE 1 opak./box [PLN]
SPP01-1	Zestaw startowy KLIPS & KLIN	1,0	100 + 50	38,00
SPP01-2	Zestaw startowy KLIPS & KLIN	1,5	100 + 50	38,00

## System poziomowania płytek - klipsy i kliny

Tile leveling system

Produkt dostępny w 2021 r.  
Product available in 2021

INDEX	NAZWA NAME	GRUBOŚĆ FUGI SIZE [mm]	ILOŚĆ [szt.] QUANTITY [pcs]	CENA / PRICE 1 opak./box [PLN]
SPP02-1	KLIPS do poziomowania płytek	1,0	100	19,90
SPP02-2	KLIPS do poziomowania płytek	1,5	100	19,90
SPP02-3	KLIPS do poziomowania płytek	2,0	100	19,90
SPP02-4	KLIPS do poziomowania płytek	3,0	100	19,90

INDEX	NAZWA NAME	ILOŚĆ [szt.] QUANTITY [pcs]	CENA / PRICE 1 opak./box [PLN]
SPP03	KLIN do poziomowania płytek	100	22,50

Akcesoria  
AccessoriesProdukt dostępny w 2021 r.  
Product available in 2021

INDEX	NAZWA NAME	ILOŚĆ [szt.] QUANTITY [pcs]	CENA / PRICE 1 opak./box [PLN]
SPP04	Szczytce do montażu klinów (podłoga)	1 / 6 / 36	67,00

## Opis produktu

System do poziomowania płytek, pozwala w szybki i łatwy sposób ułożyć płytki oszczędzając czas i eliminując niedokładności powierzchni. Stosować do płytek o grubości 7-15 mm.

## Zalety produktu

- do stosowania na ścianach i podłogach,
- pełny zakres grubości fug 1-3 mm,
- zastępuje wąskie krzyżki,
- przyspiesza układanie płytek z zachowaniem idealnych fug i połączeń,
- zapobiega przemieszczaniu podczas instalacji i wiązania kleju,
- łatwy w montażu.

## Wydajność produktu

ROZMIAR PŁYTKI TILE SIZE [cm]	30x30	33x33	40x40	45x45	50x50	60x60	80x80	60x30	100x50	120x60
ILOŚĆ [szt./m <sup>2</sup> ] QUANTITY [pcs./m <sup>2</sup> ]	42	36	20	28	24	10	10	22	16	10

## Instrukcja montażu



1 Po przyklejeniu płytki, należy z każdej dostępnej strony zainstalować po 2 klipsy wkładając je po bokach danej płytki.

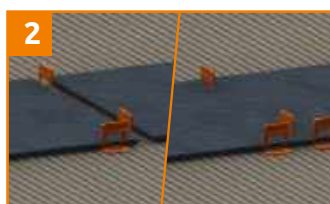

2 Dosuń kolejną płytkę do klipsów, dokładając z każdej strony po 2 klipsy.

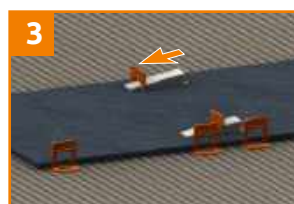

3 Włóż klin w otwór klipsa i dociśnij, aby wstępnie wyrównać kafelki. Szczytkami do montażu klinów precyzyjnie wyrównaj płytki.



4 Po zastygnięciu kleju do glazury, usuwamy klipsy lekko go uderzając w bok.

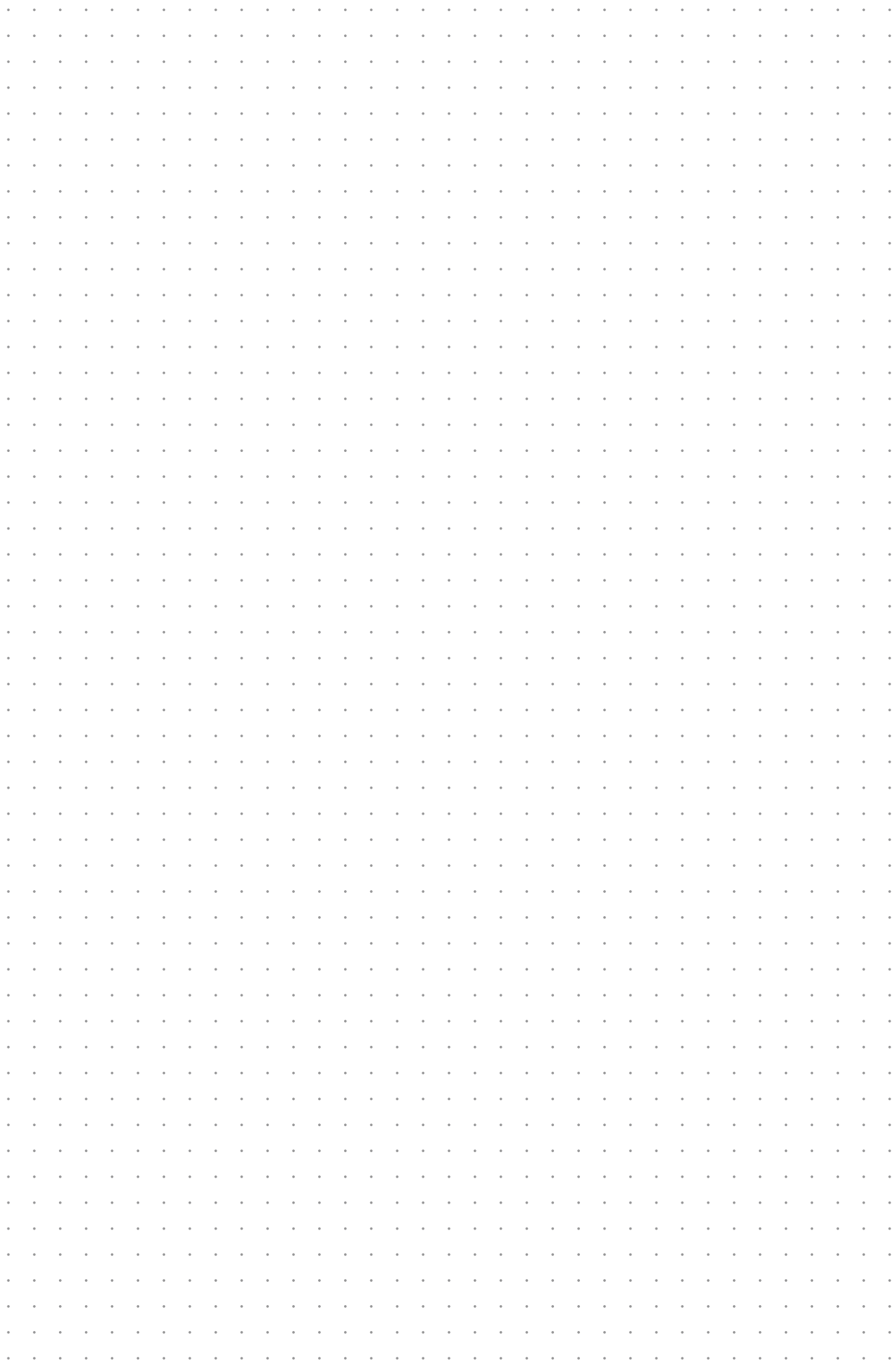

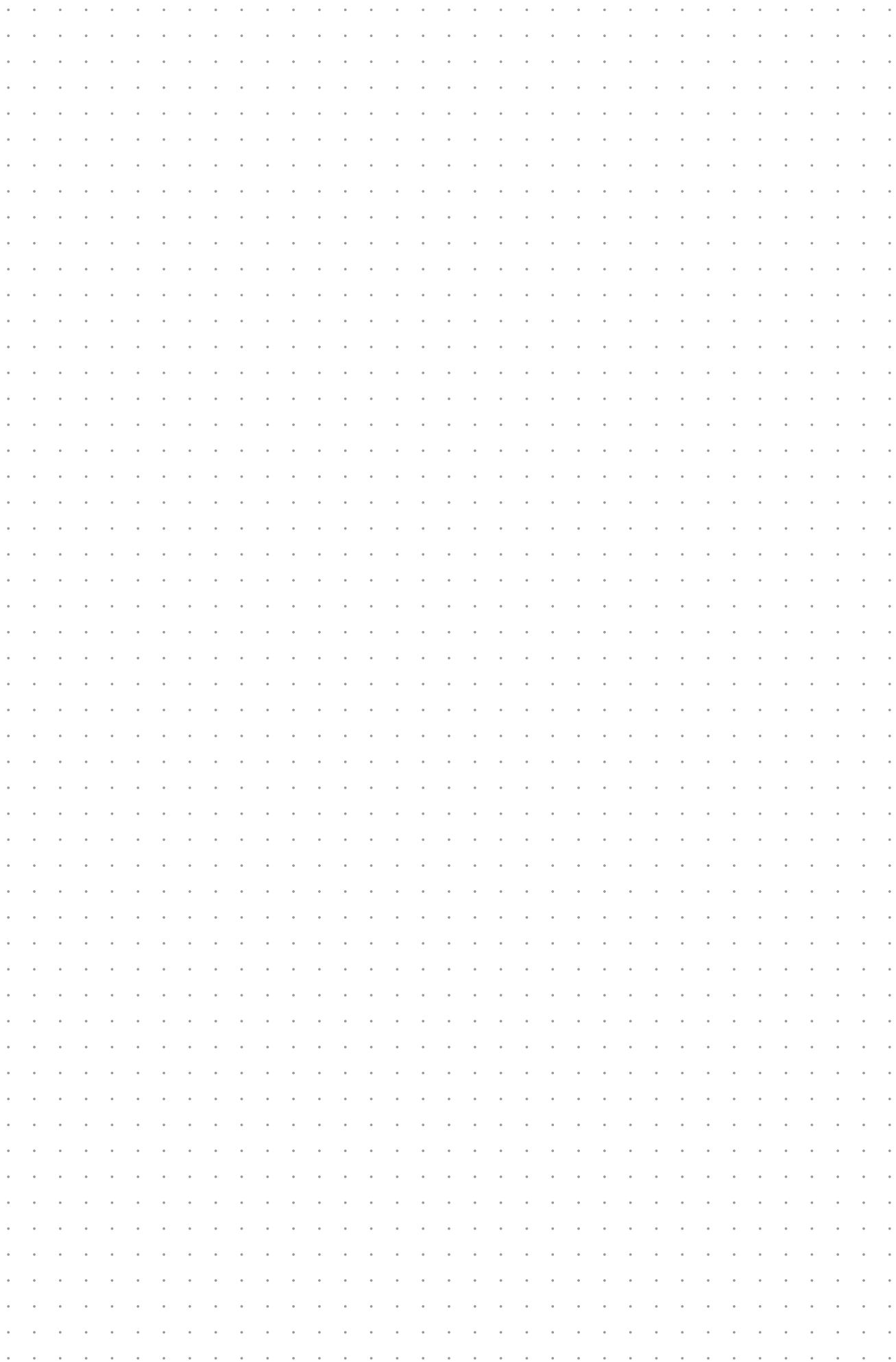

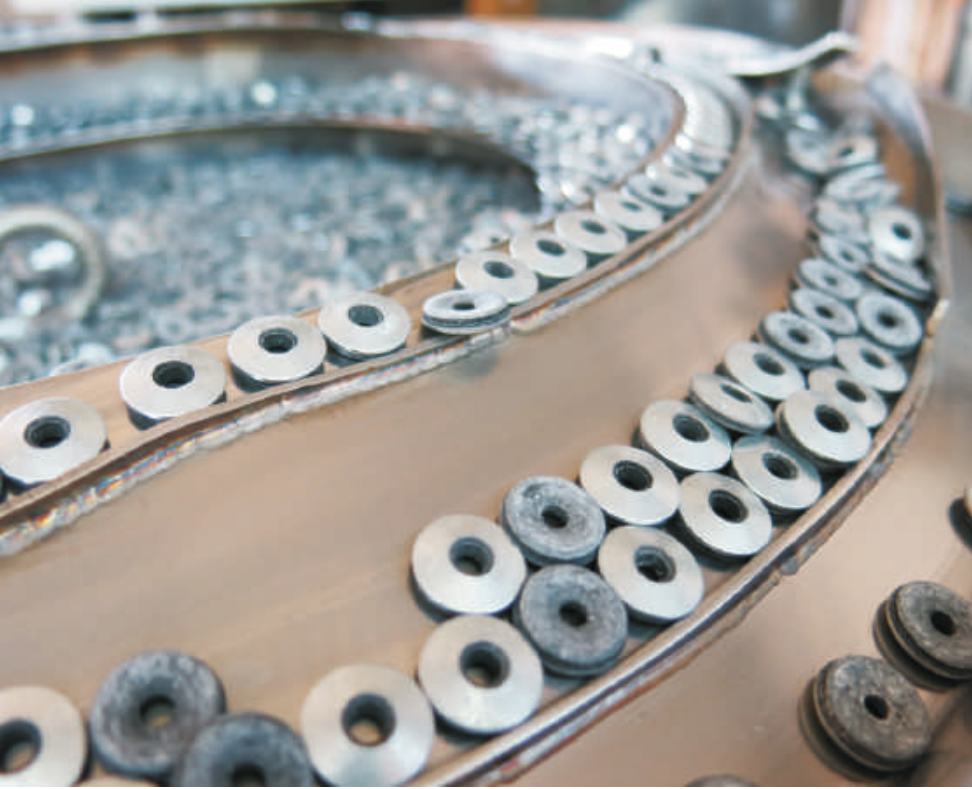



# MAG-KRAK

FASTENERS & FIXING SYSTEMS

MAG-KRAK sp. z o.o.  
ul. Karola Łowińskiego 7  
31-752 Kraków, POLAND

## EXPORT DEPARTMENT

+48 511 338 030  
m.klima@mag-krak.pl

+48 505 187 806  
r.chrobak@mag-krak.pl

## DYREKTOR HANDLOWY

+48 502 315 359 | s.bryndal@mag-krak.pl

## KIEROWNIK REGIONU PŁN.-ZACH.

+48 509 907 073 | m.motyliniski@mag-krak.pl

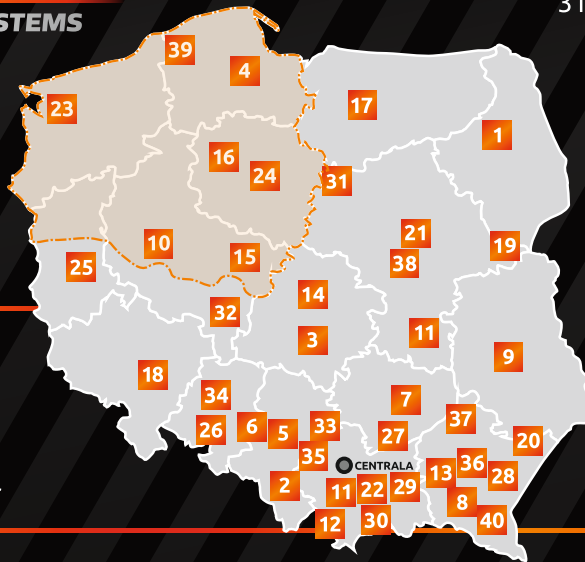

+48 12 643 51 19  
+48 12 642 03 75  
+48 12 644 08 30  
+48 12 644 07 07

biuro@mag-krak.pl  
www.mag-krak.pl  
www.k2-tools.pl

### 1. BIAŁYSTOK | SUWAŁKI | ŁOMŻA | EŁK

+48 501 032 352 | m.sosnowski@mag-krak.pl

### 2. BIELSKO-BIAŁA | NOWY TARG | ZAKOPANE

+48 502 317 335 | p.pawlowski@mag-krak.pl

### 3. ŁÓDŹ | CZĘSTOCHOWA | RADOMSKO

+48 510 202 810 | t.karas@mag-krak.pl

### 4. GDYNIA | LĘBORK | KOŚCIERZYNA | STAROGARD GD.

+48 500 045 750 | m.rusiecka@mag-krak.pl

### 5. KATOWICE | BYTOM | ZABRZE

+48 504 170 634 | j.gorecki@mag-krak.pl

### 6. OPOLE | GLIWICE | RACIBÓRZ

+48 502 269 679 | t.losa@mag-krak.pl

### 7. KIELCE | SANDOMIERZ

+48 502 124 440 | m.modzelewski@mag-krak.pl

### 8. KROSNO | NOWY SĄCZ | GORLICE

+48 507 060 688 | l.cichocki@mag-krak.pl

### 9. LUBLIN | ZAMOŚĆ | CHEŁM

+48 509 261 166 | j.sowa@mag-krak.pl

### 10. POZNAŃ | GNIEZNO | PIŁA | MIĘDZYCHÓD

+48 506 078 969 | d.szepczynski@mag-krak.pl

### 11. RADOM | PUŁAWY | GRÓJEC | ŚWIĄTNIKI G.

+48 515 278 053 | m.wlodarczyk@mag-krak.pl

### 12. SUCHA BESKIDZKA | STARY SĄCZ | JĘDRZEJÓW

+48 509 708 102 | g.gajos@mag-krak.pl

### 13. TARNÓW | RZESZÓW | DĘBICA

+48 502 345 494 | p.marzec@mag-krak.pl

### 14. ŁÓDŹ | PŁOCK | BEŁCHATÓW

+48 517 918 277 | t.szemiota@mag-krak.pl

### 15. KONIN | KOŁO | TUREK | SŁUPCA

+48 507 060 686 | t.kasierski@mag-krak.pl

### 16. BYDGOSZCZ | GRUDZIĄDZ | ŻNIN

+48 797 518 686 | m.gapska@mag-krak.pl

### 17. OLSZTYN | ELBLĄG | OSTRÓDA

+48 505 526 136 | l.wojtaszewski@mag-krak.pl

### 18. WROCŁAW | LEGNICA | JELENIA GÓRA

+48 515 331 154 | l.borkowski@mag-krak.pl

### 19. SIEDLCE | BIAŁA PODLASKA

+48 512 097 818 | p.lukomski@mag-krak.pl

### 20. BIŁGORAJ | TOMASZÓW LUBELSKI

+48 511 337 704 | m.lukasik@mag-krak.pl

### 21. WARSZAWA

+48 510 257 845 | k.golos@mag-krak.pl

### 22. KRAKÓW

+48 502 522 350 | r.bielat@mag-krak.pl

### 23. SZCZECIN | KOSZALIN | ŚWINOUJŚCIE | STARGARD

+48 508 624 081 | r.zmudzinski@mag-krak.pl

### 24. TORUŃ | WŁOCŁAWEK | BRODNICA

+48 797 400 441 | r.kaftaniak@mag-krak.pl

### 25. ZIELONA GÓRA | GORZÓW WIELKOPOLSKI

+48 534 402 102 | b.stodolna@mag-krak.pl

### 26. OPOLE | NYSA | KLUCZBORK

+48 572 702 174 | w.tomczyszyn@mag-krak.pl

### 27. BUSKO ZDRÓJ | DĄBROWA TARNOWSKA

+48 511 337 330 | a.sabala@mag-krak.pl

### 28. ŁAŃCUT | PRZEWORSK | JAROSŁAW

+48 517 116 336 | l.kuzniar@mag-krak.pl

### 29. BRZESKO | TUCHÓW

+48 517 116 354 | l.nowak@mag-krak.pl

### 30. SZCZAWNICA | PIWNICZA ZDRÓJ

+48 534 206 650 | d.dziura@mag-krak.pl

### 31. CIECHANÓW | MŁAWA | PRZASNYSZ

+48 572 570 812 | m.bukowski@mag-krak.pl

### 32. KALISZ | OSTRÓW WIELKOPOLSKI

+48 501 212 684

### 33. MYSZKÓW | ZAWIERCIE | DĄBROWA GÓRNICZA

+48 572 702 173 | t.skalski@mag-krak.pl

### 34. OPOLE | OLESNO | LUBLINIEC

+48 739 131 388 | a.matusz@mag-krak.pl

### 35. JAWORZNO | MYSŁOWICE | OLKUSZ

+48 502 705 294 | p.chochorowski@mag-krak.pl

### 36. RZESZÓW | DĘBICA | KOLBUSZOWA

+48 504 812 459 | k.zapartek@mag-krak.pl

### 37. TARNOBRZEG | STAŁOWA WOLA

+48 505 328 600 | p.grazda@mag-krak.pl

### 38. PIASECZNO | OTWOCK | GARWOLIN

+48 572 702 175 | r.kowalec@mag-krak.pl

### 39. SŁUPSK | BYTÓW | CHOJNICE | SZCZECINEK

+48 508 817 710 | r.lorens@mag-krak.pl

### 40. SANOK | LESKO

+48 512 980 199 | m.kowalczyk@mag-krak.pl